

Instruction Manual of Plarailchain SD

HIR0102-01

Thank you for purchasing PISCO Plarailchain SD Series.

In order to understand the right usage of this product, please make sure to read this instructions manual before use. (Marks, arrows, etc. in the photo are overstated for explain purposes only and may differ slightly from the actual product).

Warning

1. When connecting, disconnecting, opening and closing, or carrying out a maintenance check of Plarailchain, keep it from moving. There is a danger of self-moving or collapse by its own weight and getting injured.

2. Be careful of the flexible part of the Plarailchain. There is a danger of pinching and getting injured your hands by caught in the flexible part.

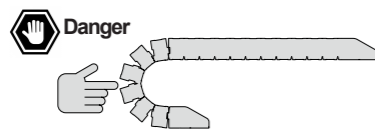

3. Please tighten up all the brackets certainly so that they do not loosen. There is a danger of breakage of the whole system if brackets loosen.

4. An inertial force, mass load, and reactive force (the force that Plarailchain is going to lug out) are added to the mounting part of the Plarailchain depending on the specification of the system. When designing the mounting part, please secure sufficient strength. There is a danger to cause damage to the whole system when the strength of the mounting part is not enough.

In addition, the reactive force can be obtained from the capability diagram of each Plarailchain.

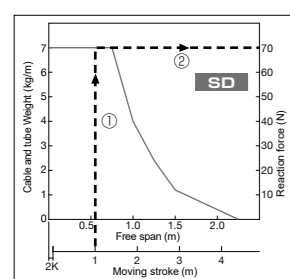

- Referring to capability diagram of the subject model, trace transfer stroke value to upper side. (as for the left diagram, this is an example when the transfer stroke value of the system is 1m.)
- From the crossing point with the capability curve, tracing it to the direction of reactive force axis. Intersected value becomes the maximum reactive force. (in the case of the left graph, the value is 60N.)

5. Do not wash the product with water. It may cause malfunction.

6. The cables and tubes to be stored in the Plarailchain should be fixed as close as possible to the attachment points on both ends. Failure to do so may cause the cables and tubes to fly out of the main unit, or may cause damage to the entire system due to excessive wear caused by tension.

7. Do not subject cables and tubes stored in the plastic rail chain to tension, twisting, extreme bending, or excessive fastening or binding. Doing so may result in crushed or broken cables, crushed tubes, ruptures, or disconnections.

8. Use dividers, racks, and rack sheets to prevent cables and tubes stored in the Plarailchain from rubbing or getting caught and scratched. This may cause cables to break or tubes to burst.

Caution

- Please check the "Plarailchain Capacity Diagram" in the digital catalog on our website carefully to select the most suitable Plarailchain. Please test it before use because there are various factors that may affect the use of the chain.
- The Plarailchain is set to expand to the outer circumference when the contents are not stored, in order to prevent drooping when the contents are stored.
- The length of the Plarailchain can be adjusted by increasing or decreasing the number of links. When designing or when length adjustment is required, please check the link calculation formula in the digital catalog on our website and calculate the required number of links.
- When installing the Plarailchain on the equipment, make sure that the fixtures at the moving end and the fixed end are installed parallel to each other along the axis of travel. If the Plarailchain runs with torsion, it may cause damage to the entire installation system.
- Cables, hoses or tubes to be stored must be excellent for flexibility and wear resistance for movement.
- Do not use the wire-braided outer ones since they are perishable.
- Depending on conditions, such as when the weight of cable or tube is heavy and the moving speed and acceleration are fast, the area around the bend may swell due to inertia at the start of moving or immediately after stopping. When designing, ensure that there is sufficient HF dimension. (HF: passable bulge height at free span length)
- The amount of cables and tubes to be stored should be within 70% of the content of the Plarailchain.
- Cables and tubes should be stored in the Plarailchain as horizontally as possible without crossing each other.
- The contents should be arranged in a well-balanced in right, left, up and down, especially if they are of different diameters so that they do not ride up and cross each other.
- Do not apply undue load to the metal bracket.
- When storing items with different contents (air tubes, water tubes, conductors, etc.) together, please select the bending radius of the Plarailchain according to the largest bending radius of the items to be stored.
- Always wear gloves and wear adequate equipment to avoid injury when using designated tools for assembly, disassembly, opening and closing flaps, etc.
- It may cause fall-out of Plarailchain or may cause disassembling during operation if the assembly is incomplete. Please carefully read the instruction manual and understand proper steps.
- A flat-blade screwdriver of which tip width 3mm is used to open the flap, so please prepare your own.

1. Factory shipped configuration

Metal brackets are not included with Plarailchain. Please purchase metal brackets separately.

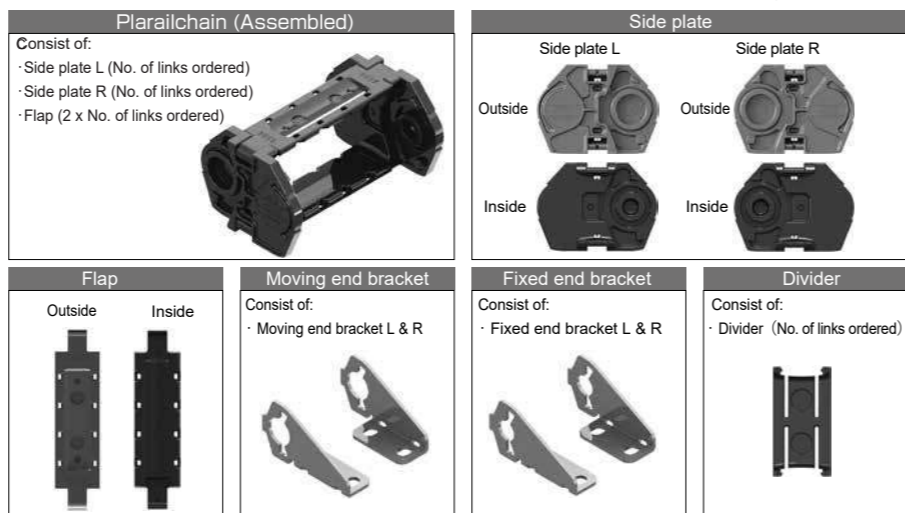

2. How to install brackets

Insert the bracket aligning the bracket hole with the boss of Plarailchain. Make sure there is no space between the brackets and the Plarailchain.

- Moving end brackets (common to inner/outer radius, inside/outside settings)
- Fixed end brackets (common to inner/outer radius, inside/outside settings)

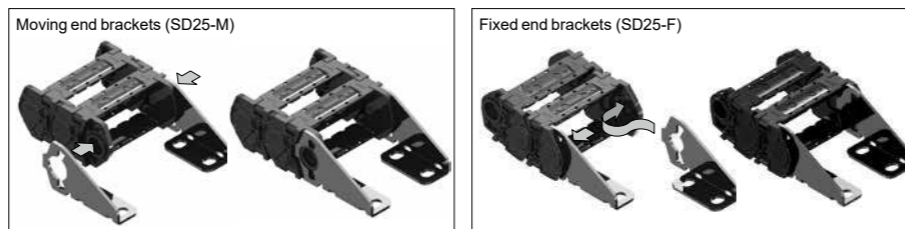

3. Opening and Closing Flap

Flaps open both sides of outer radius and inner radius

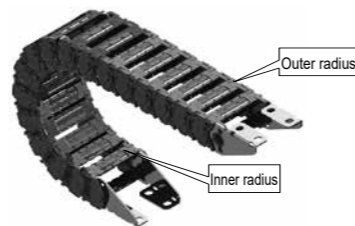

- How to open flap

(1) Insert the flat-tip driver in the slot on the side plate and lift it with the tip as the axis to open the flap.

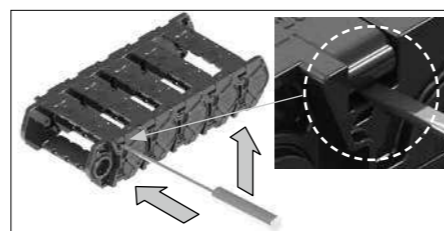

(2) Push the flaps sideways when it opens in the range of 40~55 degree to remove it.

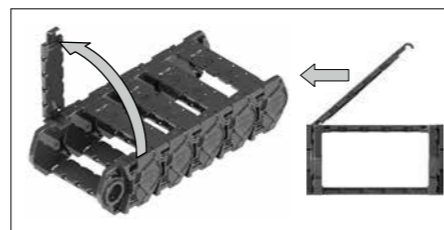

- How to close flap

Push down the flap until it clicks into place. Check if it is fixed to the side plate certainly.

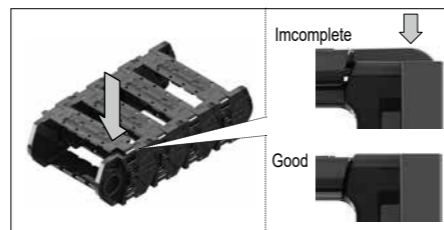

4. How to Increase Links

- Side plate assembly

Insert the side plate of R and L to the boss on each side. Plarailchain does not work if L is mounted on the R side and R is mounted on the L side.

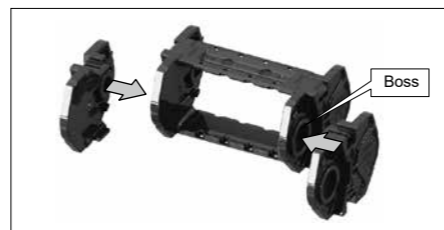

- Flap assembly

Same assembly work is done on outer and inner flap. Mount a flap to one side of the side plate by pushing it in place holding the opening angle in the range of 40~55 degree. Refer to "3. Opening and closing flap" mentioned above. Once one side of the flap is installed, push the other side of the flap in place until it clicks. Make sure the flap is certainly fixed on the side plates.

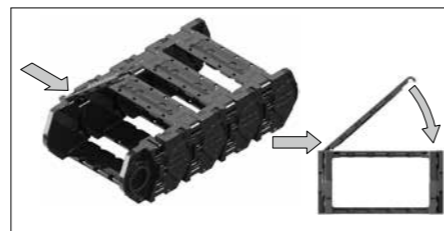

5. How to reduce links

- Open the flap referring to "3. Opening and Closing Flap"

Slide off the flap holding the opening angle in the range of 40~55 degree. Remove both the flaps of outer and inner radius.

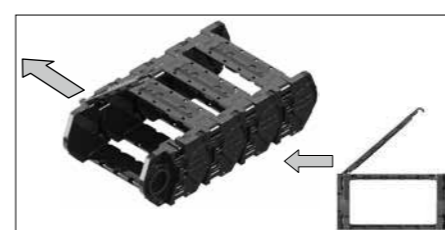

- Remove the side plates by pulling sideways

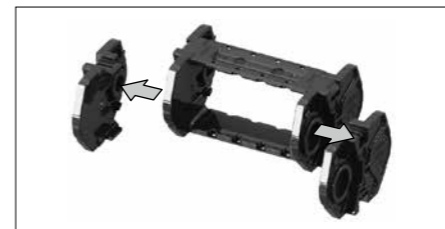

6. Connection of multiple links

Referring to "3. Opening and Closing Flap"

- Remove 2 flaps each side of inner and outer radius where you want to connect more links.



- Connect the links by pushing them from the both sides

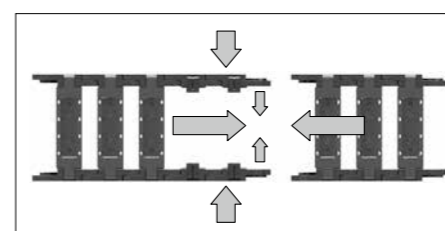

- Hold down the links from outside and inside firmly fitting the hole and the boss together.

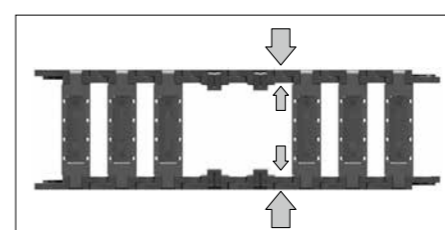

- Put back the flaps removed.



7. Separation of multiple links

Referring to "3. Opening and Closing Flap"

- Remove the 2 flaps each from outer side and inner side. Then, loosen the boss and the hole of disconnecting point by pushing them from the both sides.

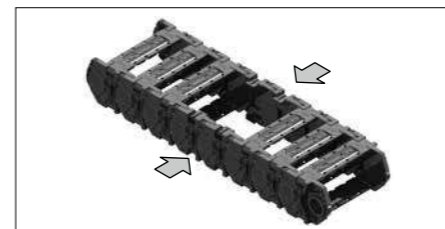

- Detach the links when the boss and the hole come off.

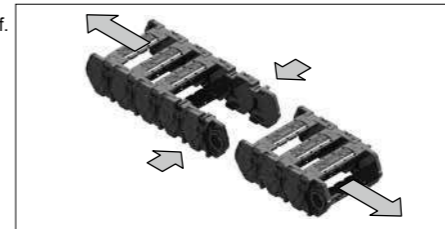

- Put back the 2 flaps removed.



8. Divider installation

Referring to "3. Opening and Closing Flap"

- Open the flap

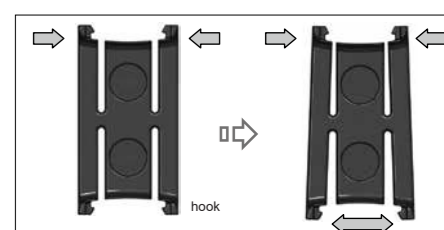

- Pinch the upper side of divider to open the bottom side.

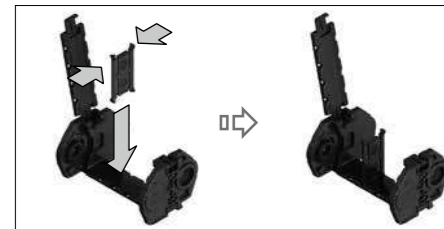

- Install the divider so that the divider hook fits to the groove on the flap.



- Close the flap.

Divider should be installed spaced from each other more than 1.1 times of the diameter of cable or tube. The pitch of groove for dividers on Plarailchain is 8.8mm for SD2550 and SD2560, and 8.7mm for SD2580

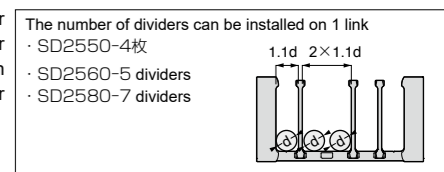

It is recommended to install the divider in every other link. Also, if multiple dividers are needed, do not install dividers next each other as much as possible.

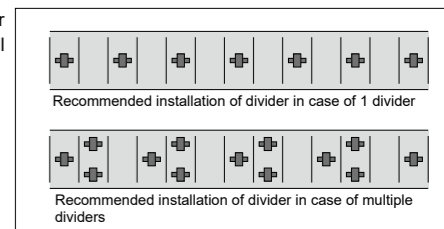

9. Cautions on Installing Cable / Tube

- The amount of cables and tubes to be stored should be within 70% of the content of the Plarailchain = internal height (h) x internal width (w). (Refer to the part of the picture on the right.)
- Select a type of cables and tubes diameter is within 80% of the inner height (h) of the Plarailchain. (Refer to the picture on the right.)

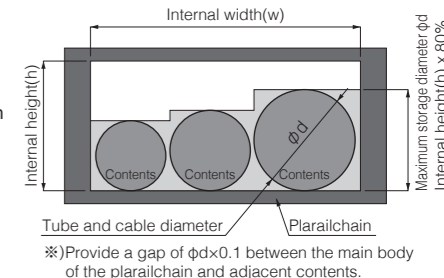

- When storing items with different contents (air tubes, water tubes, conductors, etc.) together, please select the bending radius of the plarailchain according to the largest bending radius of the items to be stored.
- By installing the divider, the contents set in array can be kept intact. This is very effective against wear and scraping.
- Cables and tubes should be stored in the plarailchain as horizontally as possible without crossing each other.
- Cables and tubes should be arranged and stored in a balanced manner.
- The contents should be arranged in a well-balanced in right, left, up and down, especially if they are of different diameters so that they do not ride up and cross each other.
- Fasten the contents at both ends of the plarailchain in order to prevent the contents from being pulled or overloaded.

NIHON PISCO CO.,Ltd.

OVERSEAS SALES TEAM
3884-1, MINAMIMINOWA, KAMINA, NAGANO-PREF, 399-4588, JAPAN
TEL: +81-(0)265-76-7751 FAX: +81-(0)265-76-3305 <https://en.pisco.co.jp/>