

New
Line Up

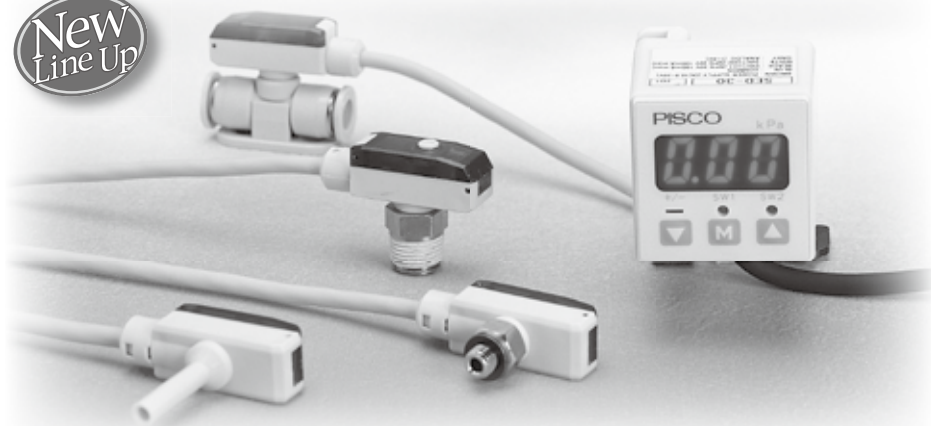

VACUUM
ACCESSORIES

Sensor Heads, Separate display type Pressure sensor and Vacuum Switch
Small Pressure Sensor 11-series

Sensor Heads

- Small-sized pressure sensor head. Width: 10mm, Height: 10mm, Length: 24.5mm
- "Union", "Nipple", and "Male screw" are available.
- Use of an analog output type and display (SED30-series) has made a separate display system possible.
- Our small-sized pressure sensors can handle "positive pressure", "negative pressure", and "Compound pressure". Switch output, a total of six different specifications are available.

Display (31mm)

- High level of visibility with its the large-sized LED display.
- All settings can be done using just three push buttons.
- 11 different types of indication units are available.
- Two different kinds of output methods are offered- analog output or switch output.
- Various types of installation: in the rear, on a flat surface, panel buried, and protection of display.
- Energy-saving by non-display mode.
- Data saving by Panel Lock.

 Copper alloy free material and against low ozone concentration on the air flow path.

Metal-parts material is non-copper metals. HNBR for seal rubber material.

Small Pressure Sensor 11-series

VACUUM GENERATOR
 EXTERNAL VACUUM CONTROLLER
 VACUUM PAD
 VACUUM ACCESSORIES

Model Designation of Sensor Heads (Example)

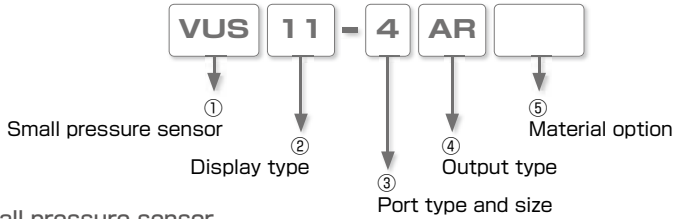

① Small pressure sensor

Code	SEU	VUS
Sensor	For Positive pressure	For Negative pressure

② Display type

Code	11
Display	No display

③ Port type and size

	Metric Thread (mm)	Push-In-Fitting (mm)		Stem Type	
Code	M5	4U	6U	4	6
Size	M5×0.8	ø4 with holder	ø6 with holder	ø4	ø6

④ Output type

Code	A	AR	S	SR
Output	Analog output	Compound type / Analog output	NPN open collector	Compound type / NPN open collector

※ . "AR" and "SR" are available with "① VUS" only.

⑤ Material option

Code	No code	-S3
Material	Standard	Copper alloy free material
Port type	All types	All types

Small Vacuum Regulator
 Ad-on Block Controller
 Vacuum Filter
 Free Holder
 Full-Pressure Valve
 5mm LED Pressure Sensor
 LED Pressure Sensor
 Small Sensor

Model Designation of Display (Example)

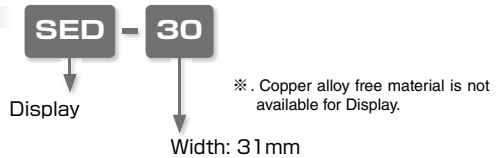

Model Designation of Individual Display accessories (Example)

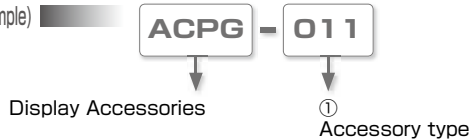

① Accessory type

Code	011	012	003	004	007
Accessory type	Wall bracket	Upright bracket	Panel holder set	Holder cover set	Holder stopper set
including	M3x4 screw (2pcs)	M3x4 screw (2pcs)	Panel holder cover, Panel holder and Panel stopper	Panel holder cover and Panel holder	Panel holder and Panel stopper

Specifications of Sensor Heads

Switch output

Series	SEU11 Series	VUS11 Series	VUS11-R Series
Fluid medium	Air / Inert gas		
Pressure detection	Diffusion type semiconductor pressure switch		
Rated voltage	DC10.8 ~ 30V (including Ripple)		
Power consumption	20mA or less (No-load at DC24V)		
Operating pressure range	0 ~ 1MPa	-100 ~ 0kPa	-100 ~ 300kPa
Proof pressure	1.5MPa	200kPa	600kPa
Storage temperature range	-20 ~ 70°C (Atmospheric pressure / Humidity: 60% RH or less)		
Operating temp. range	0 ~ 60°C (No freezing)		
Operating humidity range	35 ~ 85%RH (No dew condensation)		
Protective structure	Equivalent to IEC / IP40		
Switch output	No. of pressure setting	1	
	Switch output	NPN open collector / 30V 80mA or less / Residual voltage: 0.8V or less	
	Operation indicator	N.O. (Red LED turns ON, when pressure is above the setting)	
	Hysteresis	Fixed (2% F.S. or less)	
	Operating accuracy	±3%F.S. max. (at Ta=25°C)	
	Response time	About max. 1m·sec.	
	Pressure setting range	0 ~ 1MPa	-100 ~ 0kPa

Analog output

Series	SEU11 Series	VUS11 Series	VUS11-R Series
Fluid medium	Air / Inert gas		
Pressure detection	Diffusion type semiconductor pressure switch		
Rated voltage	DC10.8 ~ 30V (including Ripple)		
Power consumption	20mA or less (No-load at DC24V)		
Operating pressure range	0 ~ 1MPa	-100 ~ 0kPa	-100 ~ 300kPa
Proof pressure	1.5MPa	200kPa	600kPa
Storage temperature range	-20 ~ 70°C (Atmospheric pressure / Humidity: 60% RH or less)		
Operating temp. range	0 ~ 60°C (No freezing)		
Operating humidity range	35 ~ 85%RH (No dew condensation)		
Protective structure	Equivalent to IEC / IP40		
Analog output	Output voltage	1 ~ 5V	
	Zero-point voltage	1±0.1V	
	Voltage at max. rated pressure	5±0.1V	
	Output current	1mA or less (Load resistance: 5kΩ)	
	Linearity	±0.5%F.S. max. (at Ta=25°C)	

Small Pressure Sensor 11-series

Specifications of Display

Model code		SED-30		
Rated voltage		DC10.8 ~ 30V		
Power consumption		50mA or less (Rated voltage: DC10.8V / 2 switch outputs: ON)		
Storage temperature range		-20 ~ 70°C (Atmospheric pressure / Humidity: 60% RH or less)		
Operating temp. range		0 ~ 50°C (No freezing)		
Operating humidity range		35 ~ 85%RH (No dew condensation)		
Protective structure		Equivalent to IEC / IP40		
Pressure Display	Display frequency	4 times / sec.		
	Response time	Variable by digital filter (About 5, 25, 250 and 2500m·sec)		
	Display accuracy	±1%F.S.		
	Temperature characteristic	±0.5%F.S. (0~50°C (Standard temp.: 25°C))		
	Monitoring system	Out of display digit range	Blinking "999"	
		Out of pressure detection range	Blinking " _ _ _ " (Rated pressure: 110% or more)	
		Output overload detection	Applying overload current: Blinking "E-1" and Output LED	
	Zero point adjusting function	Zero point adjustment by panel control		
		Adjusting error	More than 10% F.S. of residual pressure remains in a pneumatic system during Zero point adjustment: Blinking "E2". Release it by panel control.	
	Sensor Resolution	1 digit		
	Display element	3-digit and 7-segment LED display / Height of Red LED display: 8mm		
	Sign element	Red LED (ON: negative pressure)		
Rated display range	Unit and pressure range are selectable by panel control.			
Switch Output	No. of pressure setting	2 switch outputs (SW1, SW2)		
	Switch output	NPN open collector		
	Switch capacity	DC30V 100mA max.		
	Residual voltage	Max. 1.2V (load current: 100mA)		
	Pressure adjusting method	by panel control		
	Pressure setting range	-999 ~ 999 count (Decimal point follows the rated pressure range)		
	Operation indicator	LED(SW1: Green, SW2: RED) / Blinking (Output: ON)		
	Operating accuracy	±0.2F.S. ±1count		
	Temperature characteristic	±0.5F.S. (0~50°C (Standard temp.: 25°C))		
	Response time	Changeable by digital filter (About 5, 25, 250 and 2500m·sec)		
Hysteresis adjustment	0 ~ 300count (Adjustable by digital filter)			
Overload protection	2 switch outputs (SW1, SW2) / OFF (overload current: about over 200mA or more)			
Analog output	Output voltage	1 ~ 5V		
	Output current	1mA or less (Load resistance: 5kΩ)		
Sensor input	Input signal voltage	1±0.1 ~ 5±0.1V		

Pressure sensor		VUS11-□A	VUS11-□AR	SEU11-□A
Display magnification (unit)	Pressure unit	kPa		
	Setting code	-12P	32r	13P
×1 (kPa)	Display range of rated pressure (PL ~ PH)	0.0 ~ -99.9	-100 ~ 300	0 ~ 999
×0.0102(kgf/cm ²)		0.00 ~ -1.02	-1.02 ~ 3.06	0.00 ~ (9.99)
×10.2(gf/cm ²)		0 ~ (-999)	-	-
×7.501(mmHg)		0 ~ -750	-	-
×102(mmHzO)		-	-	-
×0.01 (bar)		0.00 ~ -1.02	-1.00 ~ 3.00	0.0 ~ 9.99
×10(mbar)		0 ~ -999	-	-
×0.145(psi)		0.0 ~ -14.5	-14.5 ~ 43.5	0 ~ 145
×0.000145(Kpsi)		-	-	-
×0.001 (MPa)		-	-0.10 ~ 0.30	0.00 ~ 1.00
×0.2953(in. Hg)		0.0 ~ -29.5	-29.5 ~ -88.5	0 ~ 295
Display of analog output mode		3	1	2

Small Pressure Sensor 11-series

VACUUM GENERATOR

EXTERNAL VACUUM CONTROLLER

VACUUM PAD

VACUUM ACCESSORIES

Using Method of Sensor Head

Switch Output

- Power ON (supply DC power after checking wire arrangement)
- Adjust the pressure adjusting trimmer by the flathead screwdriver (accessory) in order to meet the desired value.
- Apply pressure and check the sensor works correctly.

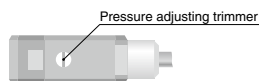

Analog Output (Sensor Head only)

- Power ON (supply DC power after checking wire arrangement)
- Check the output condition with a tester (1-5V).

Example of wiring: Switch Output

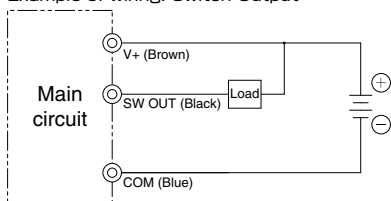

Example of wiring: Analog Output

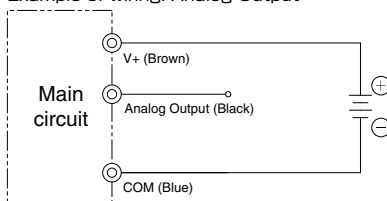

Using Method of Display

- Press terminal buttons (1-3) with a flathead driver and insert wire terminals of Sensor Head into terminal insertion ports.

- V+
- Analog OUT
- common

- Make sure that each terminal is inserted properly through the terminal check window.

- Power ON (supply DC power after checking wire arrangement)

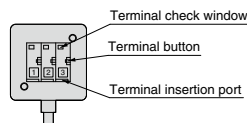

Small Vacuum Regulator

Atom Bomb Controller

Vacuum Filter

Free Holder

Full Protection Valve

5mm LED Pressure Sensor

LED Pressure Sensor

Small Sensor

Parts names and LED Display at start up

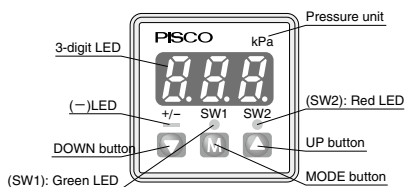

LED Display at Startup (about 3 seconds)



All LED flash off twice.



Setting code of rated pressure is displayed with flashing.



Start up Operation Mode (pressure detection).

Operation Procedure of Display

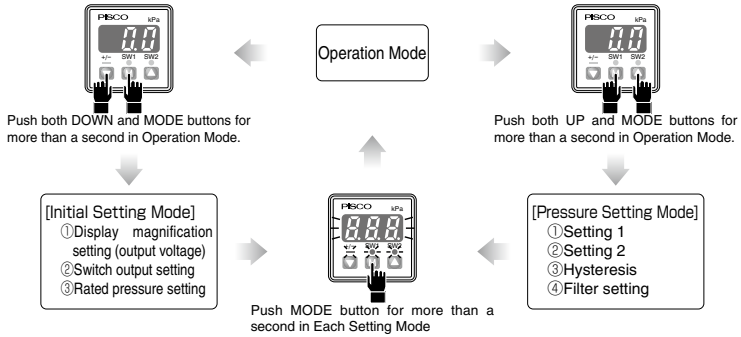

Zero Point Adjustment of Display

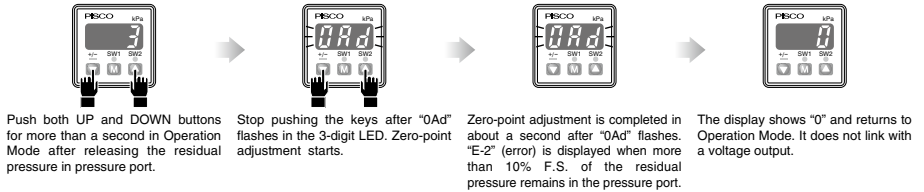

Error and Special Messages: Display

■ 3-digit LED has error messages and special indications. Refer to countermeasures below.

Messages	Error contents	Countermeasures
E-1	An overload current is supplied to SW. LED of SW1 or SW2 flashes by receiving the overload current, and both outputs turn off.	Turn off the power and check the overload condition.
E-2	Pressure is supplied or a residual pressure still remains in pressure port during Zero Point Adjustment.)	Press [MODE] button to release "[E-2]" for more than a second. Release the pressure in pressure port and adjust zero-point again.
E-3	The set data may have been lost.	Restart the Display and check initial and pressure settings. Also fluctuation of power supply voltage, startup time and surge voltage need to be checked.
E-4	Require an investigation by PISCO.	Contact us.
999	Not an error. Out of digit range.	Both switch output and output voltage are normally operated. The display "999" shows the inaccuracy of digit range.
- - -	Not an error. Out of pressure detection range.	Both switch output and output voltage are normally operated. The display "- - -" shows that the pressure detection range exceeds 110% F.S.

Small Pressure Sensor 11-series

VACUUM GENERATOR
 EXTERNAL VACUUM CONTROLLER
 VACUUM PAD
 VACUUM ACCESSORIES

■ Initial Setting Mode (Start from the rated pressure setting, when the rated pressure needs to be changed)



Push both **DOWN** and **MODE** buttons for more than a second in Operation Mode.



LED "-" flashes to indicate Display Magnification Setting, but go to the setting mode of rated pressure first. Press **MODE** button twice and skip two settings.
All settings are saved by pressing **MODE** button for a second and returns to Operation Mode (for the function of **MODE** button, the same applies to the following).



③ Three LEDs (-, SW1 and SW2) flash to indicate the setting mode of the display range of rated pressure. Factory setting is 3-digit LED "12P" (0-100kPa).
Select the range by pressing **DOWN** or **UP** button.
VUS11-□A: "-12P"
VUS11-□AR: "32r"
SEU11-□A: "13P"



When "-12P" (0-100kPa) is selected, it flashes to indicate the selection of the display range. Press **MODE** button to save the range and move the next setting.



② LED (SW2) flashes to indicate SW Output Setting. The third LED shows "4" (separate mode: L/L).
Select the code for SW Output Setting by pressing **DOWN** or **UP** button. You can return to setting ③ or save all settings and go back to Operating Mode by operating **MODE** button.



When "4" (-750) is selected, it flashes to indicate that it is "selectable". Press **MODE** button to move to the next setting. (The second digit: Output Voltage Setting is selected automatically when Display Magnification Setting is selected)



① LED "-" flashes to indicate Display Magnification Setting. The third digit shows "1" (kPa).
Select the code of Display Magnification Setting by pressing **DOWN** or **UP** button.

Caution

- Once the setting ③ of rated pressure is saved, the code set by ① and ② are automatically initiated per rated pressure range. Do not setup the above procedure after the setting ③ (rated pressure setting) is completed.
- When SW Output Setting ② is changed, especially Separate or Wind Comparator Mode is switched, the set value (1 / 2 / Hysteresis) at Pressure Setting Mode may be automatically changed in order to avoid a contradiction.

■ Output Voltage operation

- Output Voltage Setting: The code is displayed in the second digit of 3-digit LED in Initial Setting Mode.
- Output Mode is fixed per rated pressure, and can not be changed.

Output Voltage Setting			
Code	Output Mode	-Pr	+Pr
"1"	Mode R (compound pressure)	1V	5V
"2"	Mode G (positive pressure)	1V	5V
"3"	Mode V (negative pressure)	5V	1V

■ SW Output Setting / Operation Drawing

- SW Output Setting: Setup a requested mode when LED (SW2) starts flashing in Initial Setting Mode.
- Factory setting is "1" Separate Mode (HI / HI). When the setting of rated pressure is changed to negative pressure "-12P" or "-12F", SW Output Setting is initialized to "4" Separate Mode (LO / LO).

Output Mode	SW1				SW2			
	Separate	Wind Comparator	Separate	Wind Comparator	Separate	Wind Comparator	Separate	Wind Comparator
1	○				○			
2	○					○		
3		○				○		
4		○				○		
5			○				○	
6			○					○
7				○			○	
8				○				○
	Setting1	Lower limit : Setting1		Setting2	Lower limit : Setting1			Upper limit : Setting2
	Caution 1	Caution 2		Caution 1	Caution 2			

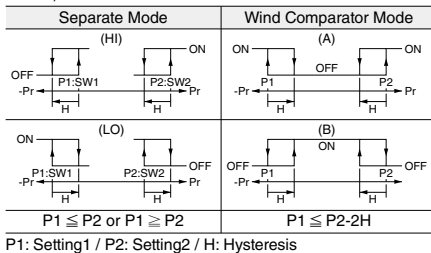

P1: Setting1 / P2: Setting2 / H: Hysteresis

Small Vacuum Regulator
 Action Block Controller
 Vacuum Filter
 Free Holder
 Solenoid Valve
 Small LED Pressure Sensor
 LED Pressure Sensor
 Small Sensor

■ Pressure Setting Mode (Setup rated pressure and SW Output Setting in Initial Setting Mode before this setting)



Push both MODE and UP buttons for more than a second in Operation Mode.



LED (SW1) starts flashing to indicate Setting Mode of Setting Value 1. When "4" (0 to -750) is selected in Display Magnification Setting, Setting Value 1 shows "-500" by 3-digit LED and "-" LED. Select a requested value by pressing DOWN or UP button.



Example) Setting Value 1: "-700" is selected. Press MODE button to the next setting. If MODE button is pressed for a second, all settings are saved and the display returns to Operation Mode (for the function of MODE button, the same applies to the following).



② LED (SW2) starts flashing to indicate Setting Mode of Setting Value 2. The display shows "-500" same as Setting Value 1. Select a requested value for Setting Value 2 by pressing DOWN or UP button.

When DOWN or UP button is pressed for a while, the speed of digital number count becomes faster. LED "-" shows minus (negative pressure).



④ LED stops flashing. "F--" will be shown on 3-digit LED which indicates Digital Filter Setting Mode. In the above figure, "F-0" (5msec) is selected. Select a requested filter setting code from 4 types (F-0, 1, 2, 3) by operating DOWN and UP button. You can return to setting ① or save all settings and go back to Operating Mode by operating MODE button.



③ LED "-" starts flashing to indicate Hysteresis Setting Mode. "20" is displayed. Select a requested value (0-300 counts) for hysteresis by operating DOWN or UP button. Press MODE button to the next setting.



Example) Setting Value 2: "0" is selected. Press MODE button to the next setting.

Caution

1. Setup SW Output Setting in Initial Setting Mode in advance. Especially when the setting Separate / Wind Comparator Mode is switched, the set value (1 / 2 / Hysteresis) in Pressure Setting Mode may be automatically changed in order to avoid a contradiction.

■ SW Output Setting / Pressure Setting

- Pressure value setting in SW (Setting Value 1 / Setting Value 2): Set a requested value, when each LED (SW1 or SW2) starts flashing in Pressure Setting Mode.
- Factory setting value is "500" for both Setting Value 1 and 2. "-500" is displayed for negative pressure (Rate pressure code "12" and "-12F"). Selectable range of setting counts is from -999 to 999. Position of a decimal point is determined by Rated Pressure or Display Magnification Setting.

Note) When Wind Comparator is selected in SW Output Setting, Setting Value 1 and 2 (P1 and P2) and Hysteresis (H) have a limited range of setting value based on the formula ($P1 \leq P2-2H$). Set a requested value of Setting Value 1 or 2 in advance, which is not restricted.

■ SW Output Setting / Hysteresis Setting

- Pressure value setting of SW (Hysteresis): Set a requested value, when LED "-" starts flashing in Pressure Setting Mode.
- Factory setting value is "20". Selectable range of setting counts is from 0 to 300. Position of a decimal point is determined by Rated Pressure or Display Magnification Setting.

Note) When Wind Comparator is selected in SW Output Setting, Setting Value 1 and 2 (P1 and P2) and Hysteresis (H) have a limited range of setting value based on the formula ($P1 \leq P2-2H$). Set a value of Hysteresis "0" first and Setting Value 1 or 2. After that, set a requested value of Hysteresis.

■ Digital Filter Setting

- Digital Filter Setting: Set a requested value, when LEDs (- / SW1 / SW2) do not flash in Pressure Setting Mode and "F-" is displayed on 3-digit LED.
- Factory setting is "F-0" (5msec). Selectable filter is "F-0", "F-1" (25msec), "F-2" (250msec) and "F-3" (2500msec). This function is useful when a detected pressure has an instant fluctuation and a difficulty in control.

Note) Filtering process for this product means averaging the data from every 5msec. cycle and providing SW output on each response time.

Small Pressure Sensor 11-series

VACUUM
GENERATOREXTERNAL VACUUM
CONTROLLERVACUUM
PADVACUUM
ACCESSORIES

829

Small Vacuum
RegulatorAuto Blow-off
ControllerVacuum
FilterFree
HolderFull Protection
Valve8mm LED
Pressure SensorLED
Pressure SensorSmall
Sensor

■ Display Magnification and Rated Pressure Setting

■ Display Magnification Setting

- Set a code of Display Magnification, when LED "-" starts flashing in Initial Setting Mode.
- Factory setting code is "1" (unit: kPa).

■ Rated Pressure Setting

- Set a code of Rated Pressure, when LEDs (- / SW1 / SW2) start flashing in Initial Setting Mode.
- Factory setting code is "12P" (rated pressure range: 0-100kPa).

Mode		Pressure type	Gauge pressure / Absolute pressure		Compound pressure
		Pressure unit	kPa		
Display Magnification Setting		Rated pressure range	0 ~ -100	0 ~ -1000	-100 ~ 300
Code	Magnification	Setting code	"-12P"	"-13P"	"32P"
1	×1 (kPa)	Rated pressure display (PL ~ PH)	0.0 -99.9	0 999	-100 300
2	×0.0102 (kgf/cm ²)		0.00 -1.02	0.00 9.99	-1.02 3.06
3	×10.2 (gf/cm ²)		0 -999		
4	×7.501 (mmHg)		0 -750		
6	×0.01 (bar)		0.00 -1.02	0.0 9.99	-1.00 3.00
7	×10 (mbar)		0 -999		
8	×0.145 (psi)		0.0 -14.5	0 145	-14.5 43.5
A	×0.001 (MPa)			0.00 1.00	-0.10 0.30
b	×0.2953 (inHg)		0 -29.5	0 295	-29.5 88.5

Other Functions

■ Non-Display Setting

- Non-Display Mode [Temporary]
 - Non-Display Mode [Temporary] starts when there is no operation for more than 10 seconds in Operation Mode.
 - LED of a decimal point starts flashing to indicate the sensor is in operation.
 - All settings are memorized in EEPROM and the data is saved even if the power turns off.
 - When an error is detected, the error notice is displayed. After the error message is released, it returns to Non-Display Mode [Temporary] again.
 - Button operation is available during Non-Display Mode. After a pressure value is displayed, it will be back to Non-Display Mode [Temporary] again.
 - Non-Display Mode [Full time] is also selectable.

(Setting / Unsetting of Function)



- Press **▼** DOWN button for 4 seconds or more in Operation Mode. Stop pressing the button once the display **0.0F** starts flashing. Non-Display Mode [Temporary] will be set and the display returns to Operation Mode. The display turns off in 10 seconds.
- In order to release the function, press **▼** DOWN button for 4 seconds or more. Stop pressing the button once the display **L 0 n** starts turning on. Non-Display Mode will be unset and the display returns to Operation Mode.

- Non-Display Mode [Full time]

- The display turns off in Operation Mode and the panel control is locked.
- LED of a decimal point turns on to indicate that Non-Display Mode [Full time] is active.
- All settings are memorized in EEPROM and the data is saved even if the power turns off.
- Once an error is detected, the error notice is displayed. After the error message is released, it returns to Non-Display Mode [Full time].
- Any button operation other than setting / unsetting of this Function will not be accepted.

(Setting / Unsetting of Function)



- Press **M** MODE button for 4 seconds or more in Operation Mode. Stop pressing the button once the display **0.0F** starts flashing. Non-Display Mode [Full time] will be set and the display returns to Operation Mode. The display turns off.
- In order to unset the function, press **M** MODE button for 4 seconds or more. Stop pressing the button once the display **L 0 n** turns on. Non-Display Mode will be unset and the display returns to Operation Mode.

■ Setting Protection (Panel Lock)

- Panel Lock Mode
 - This function protects the setting condition from misoperation by pressing buttons.
 - All settings are memorized in EEPROM and the data is saved even if power turns off.

(Setting / Unsetting of Function)



- Press **▲** UP button for 4 seconds or more in Operation Mode. Stop pressing the button once the display **PL** flashes. Panel Lock will be set and the display returns to Operation Mode. Any button operation is not available after this procedure.
- In order to unset the function, press **▲** UP button for 4 seconds or more. Stop pressing the button once the display **PR** turns on. Panel Lock will be unset and the display returns to Operation Mode. Button operation is available after this procedure.

Small Pressure Sensor 11-series

How to insert and disconnect

1. How to insert and disconnect tubes

① Tube insertion

Insert a tube into Push-In Fitting up to the tube end. Lock-claws bite the tube and fix it automatically, then the elastic sleeve seals around the tube.

Refer to "2. Instructions for Tube Insertion" under "Common Safety Instructions for Fittings" .

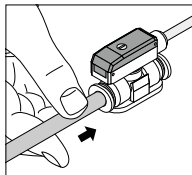

② Tube disconnection

The tube is disconnected by pushing release-ring to release Lock-claws.

Make sure to stop air supply before the tube disconnection.

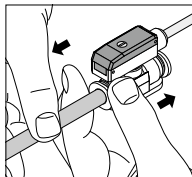

2. How to fix body

In order to fix Small Pressure Sensor 11-series, use the fixing holes on the body to tighten with M3 screws (accessory). Refer to the dimensional drawings of the hole pitch.

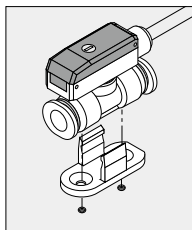

3. Assembling Method of Panel Holder Set (ACPG-003)

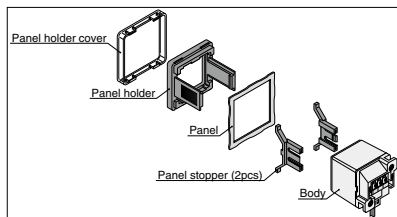

4. Assembling Method of Holder Cover Set (ACPG-004)

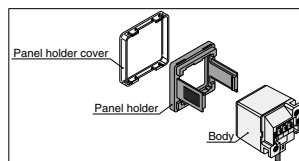

5. Assembling Method of Holder Stopper Set (ACPG-007)

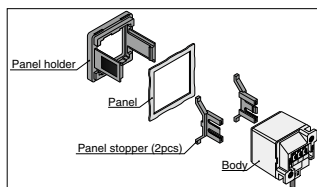

△ Detailed Safety Instructions

Before using PISCO products, be sure to read "Safety Instructions" and "Safety Instruction Manual" on page 35-39, "Common Safety Instructions for Pressure Sensors" on page 794.

Warning

1. Avoid using the sensor under the condition of corrosive gas. Also do not use the gas as a fluid medium.
2. Avoid using this product in the flammable explosive gas, liquid or ambience. This product is not designed explosive-proof and may cause fire or explosion under these conditions.
3. Use the product within the described temperature range. Otherwise, there is a possibility of malfunction of the sensor by the heat.
4. Make sure to turn off the power before wiring. Check the wire colors, and do not short-circuit output terminals, power supply terminals and COM terminals when wiring. Short-circuits may cause a sensor trouble.

Caution

1. Supply a stable DC power to the product.
2. Add a surge absorption circuit to relays or solenoid valves, etc. which are to be connected with output terminal and source terminal. Avoid any use which involves over 80mA in current.
3. Ground the FG terminal when using a unit power source such as switching current.
4. Output terminals and other terminals should not be short-circuited.
5. Avoid strong external impacts and excessive force to the sensor body.
6. Wiring or ways by which noise or other disturbance is caused may cause a sensor trouble.
7. When adjusting pressure setting, use the accompanied flathead screwdriver. Do not apply an excessive force on the trimmer. Applying excessive force may damage the sensor.
8. Keep the display (SED-30) away from water/oil drops or dusts, since it is not drip/dust proof structure.
9. For the SED-30 display's sensor heads, use "VUS 11...A" or "SEU 11...A" type analog output head. Using the head with different specifications may not achieve the required level of accuracy.
10. Avoid an excessive tensile force and bending force on a lead wire of the vacuum switch. Otherwise, there is a possibility of wire breaking and damaging the connector part.

■ Applicable Tube and Related Products

Polyurethane Tube

(1. Piping products catalog P.596)

- Polyurethane Tube is for general pneumatic piping and suitable for piping compactly.

Nylon Tube

(1. Piping products catalog P.608)

- Nylon Tube is for general pneumatic piping and suitable for a high-pressure fluid medium up to 1.5MPa (NB tube: 1.0MPa).

Vacuum Generators P.52

- Vacuum Generator changes over from compressed air to vacuum air

Small Pressure Sensor 11-series

VACUUM GENERATOR
EXTERNAL VACUUM CONTROLLER
VACUUM PAD

SEU Sensor Head / Positive Pressure / Union Type

VUS Sensor Head / Negative Pressure / Union Type

RoHS compliant

Copper alloy free
Selectable

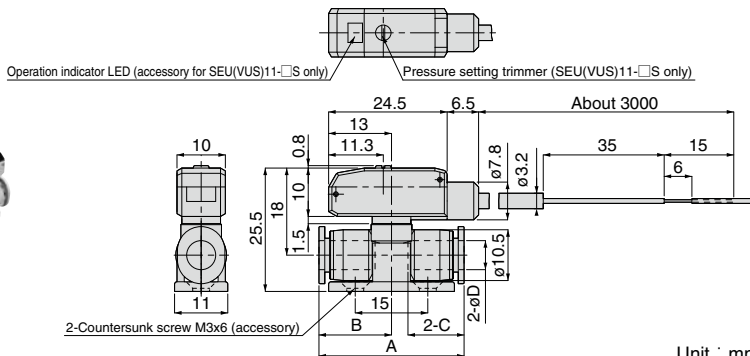

Unit : mm

Model code	Tube O.D. φD	C	A	B	Weight (g)
SEU11-4□	4	11	29.2	14.6	48
SEU11-6□	6	11.6	30	15	48
VUS11-4□	4	11	29.2	14.6	48
VUS11-6□	6	11.6	30	15	48

※ . Add "-S3" at the end of model code for air path parts "Copper alloy free" .

SEU Sensor Head / Positive Pressure / Stem Type

VUS Sensor Head / Negative Pressure / Stem Type

RoHS compliant

Copper alloy free
Selectable

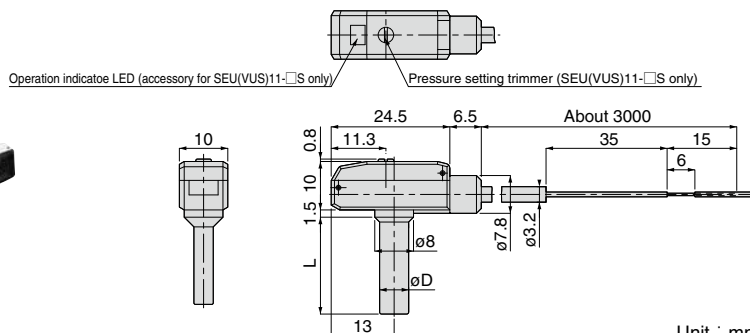

Unit : mm

Model code	Tube O.D. φD	L	Weight (g)
SEU11-4□	4	18	44
SEU11-6□	6	20	45
VUS11-4□	4	18	44
VUS11-6□	6	20	45

※ . Add "-S3" at the end of model code for a seal rubber (HNBR) as countermeasure against low ozone concentration.

Small Vacuum Regulator
Adion Block Controller
Vacuum Filter
Free Holder
Full Protection Valve
5mm LED Pressure Sensor
LED Pressure Sensor
Small Sensor

SEU Sensor Head / Positive Pressure / Metric Thread
VUS Sensor Head / Negative Pressure / Metric Thread

RoHS compliant
 Copper alloy free
 Selectable

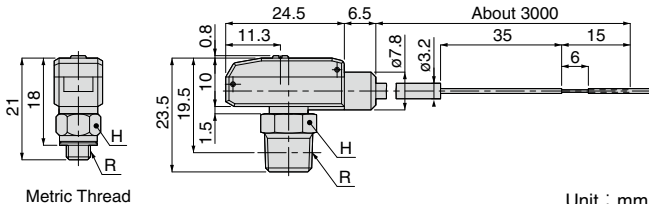
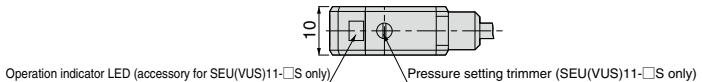

Model code	R	Hex. H	Weight (g)
SEU11-M5□	M5×0.8	8	46
SEU11-01□	R1/8	10	49
VUS11-M5□	M5×0.8	8	46
VUS11-01□	R1/8	10	49

※ . Add "-S3" at the end of model code for air path parts with copper based material free.

SED Display

RoHS compliant

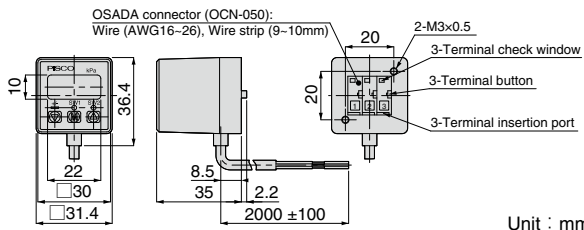

Model code	Weight (g)
SED-30	80

Lead Wire	Connection Terminal
Brown	Power (DC10.8 ~ 30V)
Blue	COMMON
Black	SW output 1
White	SW output 2
Gray	Analog output (1 ~ 5V)

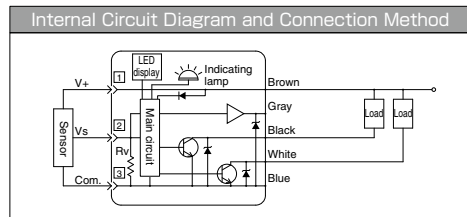

VACUUM ACCESSORIES

Small Pressure Sensor 11-series

ACPG Wall Bracket (Display Accessory)

RoHS compliant



Unit : mm

Model code	Weight (g)
ACPG-011	11

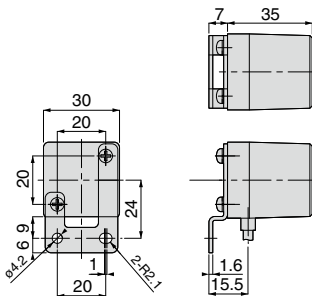

ACPG Upright Bracket (Display Accessory)

RoHS compliant



Unit : mm

Model code	Weight (g)
ACPG-012	13

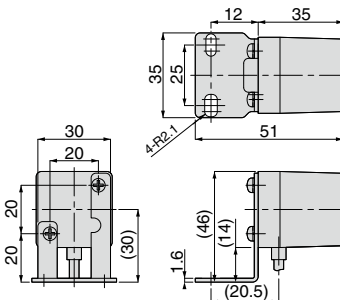

ACPG Panel Holder Set (Display Accessory)



Unit : mm

Model code	Weight (g)
ACPG-003	11

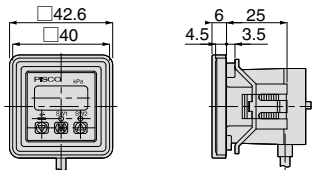

● Panel cut dimension

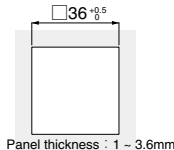

Panel thickness : 1 ~ 3.6mm

VACUUM GENERATOR
EXTERNAL VACUUM CONTROLLER
VACUUM PAD
VACUUM ACCESSORIES

835

Small Vacuum Regulator
Action Block Controller
Vacuum Filter
Free Holder
Full Protection Valve
5mm LED Pressure Sensor
LED Pressure Sensor
Small Sensor

ACPG Holder Cover Set (Display Accessory)

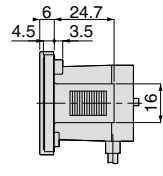
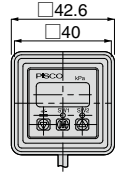

Unit : mm

Model code	Weight (g)
ACPG-004	9.5

ACPG Holder Stopper Set (Display Accessory)

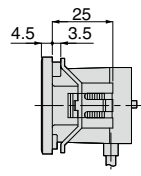
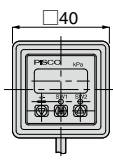

Unit : mm

Model code	Weight (g)
ACPG-007	10

● Panel cut dimension

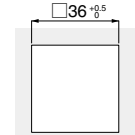

Panel thickness : 1 ~ 3.6mm

Small Pressure Sensor 11-series

VACUUM
GENERATOREXTERNAL VACUUM
CONTROLLERVACUUM
PADVACUUM
ACCESSORIES

837

Small Vacuum
RegulatorAuto On Board
ControllerVacuum
FilterFree
HolderFull Protection
Valve5mm LED
Pressure SensorLED
Pressure SensorSmall
Sensor



SAFETY Instructions

This safety instructions aim to prevent personal injury and damage to properties by requiring proper use of PISCO products.

Be certain to follow ISO 4414 and JIS B 8370

ISO 4414 : Pneumatic fluid power...Recommendations for the application of equipment to transmission and control systems.

JIS B 8370 : General rules and safety requirements for systems and their components.

This safety instructions is classified into "Danger", "Warning" and "Caution" depending on the degree of danger or damages caused by improper use of PISCO products.



Danger

Hazardous conditions. It can cause death or serious personal injury.



Warning

Hazardous conditions depending on usages. Improper use of PISCO products can cause death or serious personal injury.



Caution

Hazardous conditions depending on usages. Improper use of PISCO products can cause personal injury or damages to properties.



Warning

1. Selection of pneumatic products

- ① A user who is a pneumatic system designer or has sufficient experience and technical expertise should select PISCO products.
- ② Due to wide variety of operating conditions and applications for PISCO products, carry out the analysis and evaluation on PISCO products. The pneumatic system designer is solely responsible for assuring that the user's requirements are met and that the application presents no health or safety hazards. All designers are required to fully understand the specifications of PISCO products and constitute all systems based on the latest catalog or information, considering any malfunctions.

2. Handle the pneumatic equipment with enough knowledge and experience

- ① Improper use of compressed air is dangerous. Assembly, operation and maintenance of machines using pneumatic equipment should be conducted by a person with enough knowledge and experience.

3. Do not operate machine / equipment or remove pneumatic equipment until safety is confirmed.

- ① Make sure that preventive measures against falling work-pieces or sudden movements of machine are completed before inspection or maintenance of these machine.
- ② Make sure the above preventive measures are completed. A compressed air supply and the power supply to the machine must be off, and also the compressed air in the systems must be exhausted.
- ③ Restart the machines with care after ensuring to take all preventive measures against sudden movements.

Disclaimer

1. PISCO does not take any responsibility for any incidental or indirect loss, such as production line stop, interruption of business, loss of benefits, personal injury, etc., caused by any failure on use or application of PISCO products.
2. PISCO does not take any responsibility for any loss caused by natural disasters, fires not related to PISCO products, acts by third parties, and intentional or accidental damages of PISCO products due to incorrect usage.
3. PISCO does not take any responsibility for any loss caused by improper usage of PISCO products such as exceeding the specification limit or not following the usage the published instructions and catalog allow.
4. PISCO does not take any responsibility for any loss caused by remodeling of PISCO products, or by combinational use with non-PISCO products and other software systems.
5. The damages caused by the defect of Pisco products shall be covered but limited to the full amount of the PISCO products paid by the customer.



SAFETY INSTRUCTION MANUAL

PISCO products are designed and manufactured for use in general industrial machines. Be sure to read and follow the instructions below.

⚠ Danger

1. Do not use PISCO products for the following applications.
 - ① Equipment used for maintaining / handling human life and body.
 - ② Equipment used for moving / transporting human.
 - ③ Equipment specifically used for safety purposes.

⚠ Warning

1. Do not use PISCO products under the following conditions.
 - ① Beyond the specifications or conditions stated in the catalog, or the instructions.
 - ② Under the direct sunlight or outdoors.
 - ③ Excessive vibrations and impacts.
 - ④ Exposure / adhere to corrosive gas, inflammable gas, chemicals, seawater, water and vapor. *
 - * Some products can be used under the condition above(④), refer to the details of specification and condition of each product.
2. Do not disassemble or modify PISCO products, which affect the performance, function, and basic structure of the product.
3. Turn off the power supply, stop the air supply to PISCO products, and make sure there is no residual air pressure in the pipes before maintenance and inspection.
4. Do not touch the release-ring of push-in fitting when there is a working pressure. The lock may be released by the physical contact, and tube may fly out or slip out.
5. Frequent switchover of compressed air may generate heat, and there is a risk of causing burn injury.
6. Avoid any load on PISCO products, such as a tensile strength, twisting and bending. Otherwise, there is a risk of causing damage to the products.
7. As for applications where threads or tubes swing / rotate, use Rotary Joints, High Rotary Joints or Multi-Circuit Rotary Block only. The other PISCO products can be damaged in these applications.
8. Use only Die Temperature Control Fitting Series, Tube Fitting Stainless SUS316 Series, Tube Fitting Stainless SUS316 Compression Fitting Series or Tube Fitting Brass Series under the condition of over 60°C (140° F) water or thermal oil. Other PISCO products can be damaged by heat and hydrolysis under the condition above.
9. As for the condition required to dissipate static electricity or provide an antistatic performance, use EG series fitting and antistatic products only, and do not use other PISCO products. There is a risk that static electricity can cause system defects or failures.
10. Use only Fittings with a characteristic of spatter-proof such as Anti-spatter or Brass series in a place where flame and weld spatter is produced. There is a risk of causing fire by sparks.
11. Turn off the power supply to PISCO products, and make sure there is no residual air pressure in the pipes and equipment before maintenance. Follow the instructions below in order to ensure safety.
 - ① Make sure the safety of all systems related to PISCO products before maintenance.
 - ② Restart of operation after maintenance shall be proceeded with care after ensuring safety of the system by preventive measures against unexpected movements of machines and devices where pneumatic equipment is used.
 - ③ Keep enough space for maintenance when designing a circuit.
12. Take safety measures such as providing a protection cover if there is a risk of causing damages or fires on machine / facilities by a fluid leakage.

⚠ Caution

1. Remove dusts or drain before piping. They may get into the peripheral machine / facilities and cause malfunction.
2. When inserting an ultra-soft tube into push-in fitting, make sure to place an Insert Ring into the tube edge. There is a risk of causing the escape of tube and a fluid leakage without using an Insert Ring.
3. The product incorporating NBR as seal rubber material has a risk of malfunction caused by ozone crack. Ozone exists in high concentrations in static elimination air, clean-room, and near the high-voltage motors, etc. As a countermeasure, material change from NBR to HNBR or FKM is necessary. Consult with PISCO for more information.
4. Special option "Oil-free" products may cause a very small amount of a fluid leakage. When a fluid medium is liquid or the products are required to be used in harsh environments, contact us for further information.
5. In case of using non-PISCO brand tubes, make sure the tolerance of the outer tube diameter is within the limits of Table 1.

● Table 1. Tube O.D. Tolerance

mm size	Nylon tube	Polyurethane tube	inch size	Nylon tube	Polyurethane tube
ø1.8mm	—	± 0.05mm	ø1/8	± 0.1mm	± 0.15mm
ø3mm	—	± 0.15mm	ø5/32	± 0.1mm	± 0.15mm
ø4mm	± 0.1mm	± 0.15mm	ø3/16	± 0.1mm	± 0.15mm
ø6mm	± 0.1mm	± 0.15mm	ø1/4	± 0.1mm	± 0.15mm
ø8mm	± 0.1mm	± 0.15mm	ø5/16	± 0.1mm	± 0.15mm
ø10mm	± 0.1mm	± 0.15mm	ø3/8	± 0.1mm	± 0.15mm
ø12mm	± 0.1mm	± 0.15mm	ø1/2	± 0.1mm	± 0.15mm
ø16mm	± 0.1mm	± 0.15mm	ø5/8	± 0.1mm	± 0.15mm

6. Instructions for Tube Insertion

- ① Make sure that the cut end surface of the tube is at right angle without a scratch on the surface and deformations.
- ② When inserting a tube, the tube needs to be inserted fully into the push-in fitting until the tubing edge touches the tube end of the fitting as shown in the figure below. Otherwise, there is a risk of leakage.

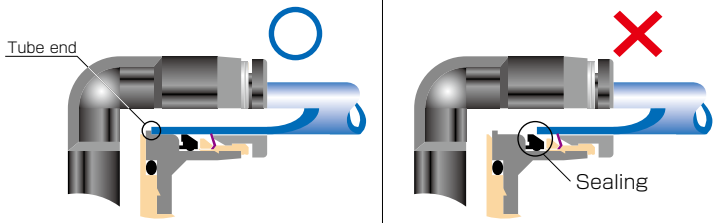

Tube is not fully inserted up to tube end.

- ③ After inserting the tube, make sure it is inserted properly and not to be disconnected by pulling it moderately.
- ※ When inserting tubes, Lock-claws may be hardly visible in the hole, observed from the front face of the release-ring. But it does not mean the tube will surely escape. Major causes of the tube escape are the followings;
- ① Shear drop of the lock-claws edge
 - ② The problem of tube diameter (usually small)
- Therefore, follow the above instructions from ① to ③, even lock-claws is hardly visible.

7. Instructions for Tube Disconnection

- ① Make sure there is no air pressure inside of the tube, before disconnecting it.
- ② Push the release-ring of the push-in fitting evenly and deeply enough to pull out the tube toward oneself. By insufficient pushing of the release-ring, the tube may not be pulled out or damaged by scratch, and tube shavings may remain inside of the fitting, which may cause the leakage later.

8. Instructions for Installing a fitting

- ① When installing a fitting, use proper tools to tighten a hexagonal-column or an inner hexagonal socket. When inserting a hex key into the inner hexagonal socket of the fitting, be careful so that the tool does not touch lock-claws. The deformation of lock-claws may result in a poor performance of systems or an escape of the tube.
- ② Refer to Table 2 which shows the recommended tightening torque. Do not exceed these limits to tighten a thread. Excessive tightening may break the thread part or deform the gasket and cause a fluid leakage. Tightening thread with tightening torque lower than these limits may cause a loosened thread or a fluid leakage.
- ③ Adjust the tube direction while tightening thread within these limits, since some PISCO products are not rotatable after the installation.

● Table 2: Recommended tightening torque / Sealock color / Gasket materials

Thread type	Thread size	Tightening torque	Sealock color	Gasket materials
Metric thread	M3 × 0.5	0.7N·m	—	SUS304 NBR
	M5 × 0.8	1.0 ~ 1.5N·m		
	M6 × 1	2 ~ 2.7N·m		
	M3 × 0.5	0.5 ~ 0.6N·m		POM
	M5 × 0.8	1 ~ 1.5N·m		
	M6 × 0.75	0.8 ~ 1N·m		
Taper pipe thread	M8 × 0.75	1 ~ 2N·m	White	—
	R1/8	7 ~ 9N·m		
	R1/4	12 ~ 14N·m		
	R3/8	22 ~ 24N·m		
Unified thread	R1/2	28 ~ 30N·m	—	SUS304, NBR
	No.10-32UNF	1.0 ~ 1.5N·m		
National pipe thread taper	1/16-27NPT	7 ~ 9N·m	White	—
	1/8-27NPT	7 ~ 9N·m		
	1/4-18NPT	12 ~ 14N·m		
	3/8-18NPT	22 ~ 24N·m		
	1/2-14NPT	28 ~ 30N·m		

※ These values may differ for some products. Refer to each specification as well.

9. Instructions for removing a fitting

- ① When removing a fitting, use proper tools to loosen a hexagonal-column or an inner hex bolt.
- ② Remove the sealant stuck on the mating equipment. The remained sealant may get into the peripheral equipment and cause malfunctions.

10. Arrange piping avoiding any load on fittings and tubes such as twist, tensile, moment load, shaking and physical impact. These may cause damages to fittings, tube deformations, bursting and the escape of tubes.



Common Safety Instructions for Pressure Sensors

Before selecting or using PISCO products, read the following information. Regarding the instructions of each series, please follow each Detailed Safety Instructions.

⚠ Warning

1. Avoid an excessive tensile strength, twisting force, bending, dropping and strong impact on pressure sensors. Otherwise, there is a possibility of damaging the products.
2. Supply clean air to the operating pressure source. There is a possibility of malfunction of sensors by sludge or dusts.

⚠ Caution

1. Refer to “Common Safety Instructions for Fittings” for handling Fittings.
2. Instructions for Installation
 - ①. Use a proper tool to tighten hexagonal-columns of body.
 - ②. Refer to the following recommended tightening torque to tighten thread. Do not exceed these limits to tighten a thread. Excessive tightening may break the thread part or deform the gasket to cause a fluid leakage. Tightening thread with tightening torque less than these limits may cause a loosened thread or fluid leakage.

● Table: Recommended tightening torque (Hexagonal-column)

Thread type	Thread size	Tightening torque
Metric thread	M5×0.8	1.5 ~ 1.9N·m
Taper pipe thread	R1/8	7 ~ 9N·m

3. Instructions for Removal

- ①. Use a proper tool to tighten hexagonal-columns of body.
- ②. Remove the sealant stuck on the mating equipment. The remained sealant may get into the peripheral equipment and cause malfunctions.