



2-Circuit Junction Block for Pneumatic Piping 2-Circuit Junction Block Series

- *Add-On Fittings of Dual-Line.*
- *Inserting Connection. Adjustable by Adding and Removing Blocks.*
- *Different Release-Ring Color Selection for Each Line.*
- *Usable for Cooling Down Piping.*

2-Circuit Junction Block

Model Designation (Example)

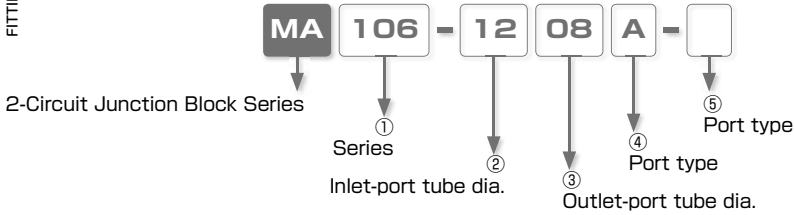

① Series

106 : 106 series (Fixed type)

107 : 107 series (Free type)

② Inlet-port tube dia. (* Port type: A(Inlet port) only)

Tube size	mm size	
Code	10	12
Size (mm)	ø10	ø12

③ Outlet-port tube dia. (*.107 series Port type: except A(Inlet port))

Tube size	mm size	
Code	06	08
Size (mm)	ø6	ø8

④ Port type

Code	Type	Code	Type	Code	Type
A	Inlet port	B	Middle outlet port	C	End outlet port

⑤ Release ring color (* 107 series Port type: B(Middle outlet port), C(End outlet port) only)

No code : Black and Red

B : Black only

R : Red only

● Model Designation of 107 series bracket

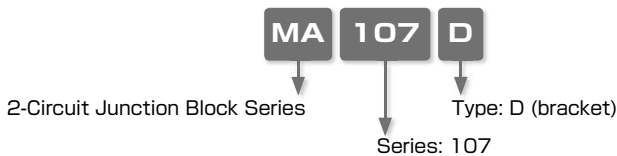

Specifications

Fluid medium	Air / Water (※)
Max. operating pressure	0.9MPa
Max. vacuum	-100kPa
Operating temp. range	0-60℃ (No freezing)

△ Warning

※ . Make sure to follow the instructions below when the fluid medium is water.

1. Surge pressure must be controlled lower than max. operating pressure when using water as a fluid medium.
2. Tap water can be used. Consult us for using other kind of water.
3. Be sure to place Insert Ring into the tube edge when using water as a fluid medium.

Construction (107 series: Middle outlet port)

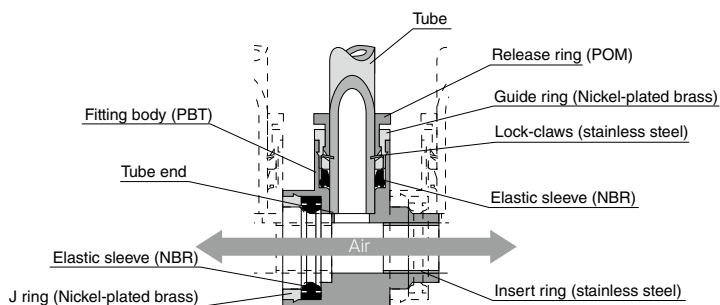

△ Detailed Safety Instructions

Before using PISCO products, be sure to read "Safety Instructions" and "Safety Instruction Manual" on page 23 to 27 and "Common Safety Instructions for Fittings" on page 33 to 35.

Warning

1. When the fluid medium is water, do not use 2-Circuit Junction Block Series unless the operating environment meets all the described specifications in the catalog. Otherwise, it may cause damage to the products, the escape of tubes and a fluid leakage.
2. Make sure to fix the blocks with bolts or a bracket. In case of improper fixing, there is a possibility to cause the separation of the blocks or a fluid leakage.

Caution

1. As for connecting each block, insert the block properly until a block body is fixed. Improper insertion may cause a fluid leakage.

Standard Size List

106 series

Type	Page	Inlet-port tube dia. O.D. (mm)		Outlet-port tube dia. O.D. (mm)	
		6	8	6	8
MA106 Inlet port	P.331	10	●	●	●
		12	●	●	●

Type	Page	Tube dia. O.D. (mm)	
		6	8
MA106 Middle outlet port	P.331	●	●
MA106 End outlet port	P.331	●	●

107 series

Type	Page	Tube dia. O.D. (mm)	
		10	12
MA107 Inlet port	P.332	●	●

Type	Page	Tube dia. O.D. (mm)	
		6	8
MA107 Middle outlet port	P.332	●	●
MA107 End outlet port	P.332	●	●

How to use 106 series and 107 series properly

■ As for 106 series, the position of the air outlet port is fixed, when connecting blocks.

■ As for 107 series, the position of middle and end outlet port is free to move, even after connecting the block.

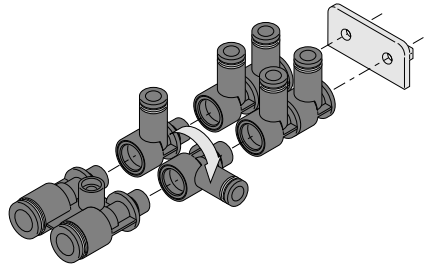
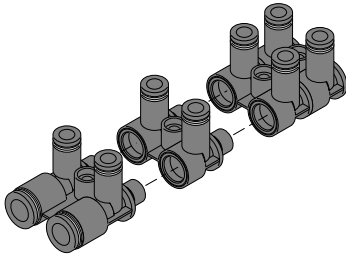

■ How to insert and disconnect

1. How to insert and disconnect tubes

① Tube insertion

Insert a tube into Push-In Fitting up to the tube end. Lock-claws bite the tube and fix it automatically, then the elastic sleeve seals around the tube.

Refer to "2. Instructions for Tube Insertion" under "Common Safety Instructions for Fittings" .

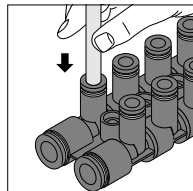

② Tube disconnection

The tube is disconnected by pushing release-ring to release Lock-claws.

Make sure to stop air supply before the tube disconnection.

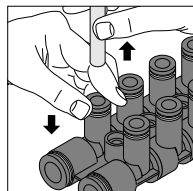

2. How to fix ports

① Drill tapping holes for screw "M6" on the mounted side in advance. In order to fix 106 series, use holes of inlet port A and end outlet port C and the drilled tapping holes for M6. Refer to dimensions about the distance of the holes pitch in the catalog.

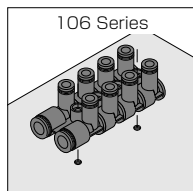

② Drill tapping holes for screw "M6" on the mounted side in advance. In order to fix 107 series, use holes of inlet port A and bracket holes. Refer to dimensions about the distance of the holes pitch in the catalog.

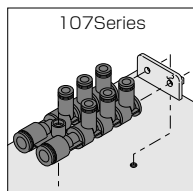

■ Applicable Tube and Related Products

Polyurethane Tube·····P.596

Nylon Tube·····P.608

106 series (Fixed type)

FITTING

MA106 Inlet port

RoHS compliant

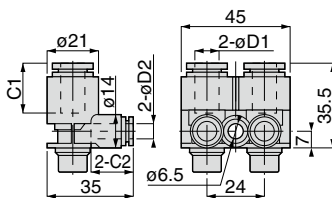

Unit : mm

Model code	Tube O.D. øD1	Tube O.D. øD2	Tube end C1	Tube end C2	Weight (g)	Orifice dia.	CAD file name
MA106-1006A	10	6	20.5	17	36.5	4.6	MA106-1006A
MA106-1008A		8		18.5	37	6	MA106-1008A
MA106-1206A	12	6	23.5	17	38.5	4.6	MA106-1206A
MA106-1208A		8		18.5	39	6	MA106-1208A

MA106 Middle outlet port

RoHS compliant

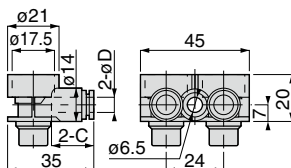

Unit : mm

Model code	Tube O.D. øD	Tube end C	Weight (g)	Orifice dia.	CAD file name
MA106-06B	6	17	24.5	4.6	MA106-06B
MA106-08B	8	18.5	25.5	6	MA106-08B

MA106 End outlet port

RoHS compliant

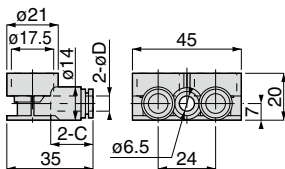

Unit : mm

Model code	Tube O.D. øD	Tube end C	Weight (g)	Orifice dia.	CAD file name
MA106-06C	6	17	22.5	4.6	MA106-06C
MA106-08C	8	18.5	23.5	6	MA106-08C

107 series (Middle and end outlet port / movable type)

MA107 Inlet port

RoHS compliant

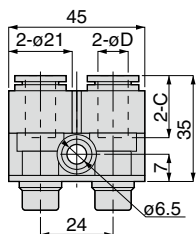

Unit : mm

Model code	Tube O.D. øD	Tube end C	Weight (g)	Orifice dia.	CAD file name
MA107-10A	10	20	20	9	MA107-10A
MA107-12A	12	23.5	23.5	9	MA107-12A

MA107 Middle outlet port

RoHS compliant

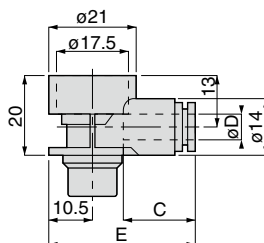

Unit : mm

Model code	Tube O.D. øD	Tube end C	E	Weight (g)	Orifice dia.	CAD file name
MA107-06B-□	6	17	35	10.5	4.6	MA107-06B-□
MA107-08B-□	8	18	34.5	12	6	MA107-08B-□

※. □ in Model code/ Replaced with "B" for release ring color Black & Black, "R" for Red & Red, No code for Black & Red (2ports per set.)

MA107 End outlet port

RoHS compliant

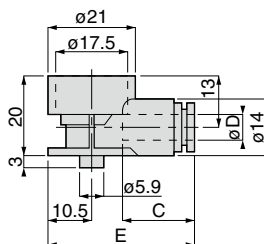

Unit : mm

Model code	Tube O.D. øD	Tube end C	E	Weight (g)	Orifice dia.	CAD file name
MA107-06C-□	6	17	35	10.5	4.6	MA107-06C-□
MA107-08C-□	8	18	34.5	11	6	MA107-08C-□

※. □ in Model code/ Replaced with "B" for release ring color Black & Black, "R" for Red & Red, No code for Black & Red (2ports per set.)

■ 107 series (Middle and end outlet port / movable type)

FITTING

MA107 Bracket for 107 series

RoHS compliant

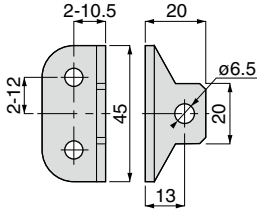

CAD

Model code	Weight (g)	CAD file name
MA 107D	27	TF2J-002

333

Standard Series

Mini Series

Stainless Series

Chemical Series

PP Series

EG Series

Anti-separator & Brass Series

De Temperature Control

Minimal Series

Stop Fitting Series

Pottery Series

Twist-Proof Fitting

Block and Connector



SAFETY Instructions

This safety instructions aim to prevent personal injury and damage to properties by requiring proper use of PISCO products.

Be certain to follow ISO 4414 and JIS B 8370

ISO 4414 : Pneumatic fluid power...Recommendations for the application of equipment to transmission and control systems.

JIS B 8370 : General rules and safety requirements for systems and their components.

This safety instructions is classified into "Danger", "Warning" and "Caution" depending on the degree of danger or damages caused by improper use of PISCO products.



Danger

Hazardous conditions. It can cause death or serious personal injury.



Warning

Hazardous conditions depending on usages. Improper use of PISCO products can cause death or serious personal injury.



Caution

Hazardous conditions depending on usages. Improper use of PISCO products can cause personal injury or damages to properties.



Warning

1. Selection of pneumatic products

- ① A user who is a pneumatic system designer or has sufficient experience and technical expertise should select PISCO products.
- ② Due to wide variety of operating conditions and applications for PISCO products, carry out the analysis and evaluation on PISCO products. The pneumatic system designer is solely responsible for assuring that the user's requirements are met and that the application presents no health or safety hazards. All designers are required to fully understand the specifications of PISCO products and constitute all systems based on the latest catalog or information, considering any malfunctions.

2. Handle the pneumatic equipment with enough knowledge and experience

- ① Improper use of compressed air is dangerous. Assembly, operation and maintenance of machines using pneumatic equipment should be conducted by a person with enough knowledge and experience.

3. Do not operate machine / equipment or remove pneumatic equipment until safety is confirmed.

- ① Make sure that preventive measures against falling work-pieces or sudden movements of machine are completed before inspection or maintenance of these machine.
- ② Make sure the above preventive measures are completed. A compressed air supply and the power supply to the machine must be off, and also the compressed air in the systems must be exhausted.
- ③ Restart the machines with care after ensuring to take all preventive measures against sudden movements.

Disclaimer

1. PISCO does not take any responsibility for any incidental or indirect loss, such as production line stop, interruption of business, loss of benefits, personal injury, etc., caused by any failure on use or application of PISCO products.
2. PISCO does not take any responsibility for any loss caused by natural disasters, fires not related to PISCO products, acts by third parties, and intentional or accidental damages of PISCO products due to incorrect usage.
3. PISCO does not take any responsibility for any loss caused by improper usage of PISCO products such as exceeding the specification limit or not following the usage the published instructions and catalog allow.
4. PISCO does not take any responsibility for any loss caused by remodeling of PISCO products, or by combinational use with non-PISCO products and other software systems.
5. The damages caused by the defect of Pisco products shall be covered but limited to the full amount of the PISCO products paid by the customer.



SAFETY INSTRUCTION MANUAL

PISCO products are designed and manufactured for use in general industrial machines. Be sure to read and follow the instructions below.

Danger

1. Do not use PISCO products for the following applications.
 - ① Equipment used for maintaining / handling human life and body.
 - ② Equipment used for moving / transporting human.
 - ③ Equipment specifically used for safety purposes.

Warning

1. Do not use PISCO products under the following conditions.
 - ① Beyond the specifications or conditions stated in the catalog, or the instructions.
 - ② Under the direct sunlight or outdoors.
 - ③ Excessive vibrations and impacts.
 - ④ Exposure / adhere to corrosive gas, inflammable gas, chemicals, seawater, water and vapor. *
* Some products can be used under the condition above(④), refer to the details of specification and condition of each product.
2. Do not disassemble or modify PISCO products, which affect the performance, function, and basic structure of the product.
3. Turn off the power supply, stop the air supply to PISCO products, and make sure there is no residual air pressure in the pipes before maintenance and inspection.
4. Do not touch the release-ring of push-in fitting when there is a working pressure. The lock may be released by the physical contact, and tube may fly out or slip out.
5. Frequent switchover of compressed air may generate heat, and there is a risk of causing burn injury.
6. Avoid any load on PISCO products, such as a tensile strength, twisting and bending. Otherwise, there is a risk of causing damage to the products.
7. As for applications where threads or tubes swing / rotate, use Rotary Joints, High Rotary Joints or Multi-Circuit Rotary Block only. The other PISCO products can be damaged in these applications.
8. Use only Die Temperature Control Fitting Series, Tube Fitting Stainless SUS316 Series, Tube Fitting Stainless SUS316 Compression Fitting Series or Tube Fitting Brass Series under the condition of over 60°C (140° F) water or thermal oil. Other PISCO products can be damaged by heat and hydrolysis under the condition above.
9. As for the condition required to dissipate static electricity or provide an antistatic performance, use EG series fitting and antistatic products only, and do not use other PISCO products. There is a risk that static electricity can cause system defects or failures.
10. Use only Fittings with a characteristic of spatter-proof such as Anti-spatter or Brass series in a place where flame and weld spatter is produced. There is a risk of causing fire by sparks.
11. Turn off the power supply to PISCO products, and make sure there is no residual air pressure in the pipes and equipment before maintenance. Follow the instructions below in order to ensure safety.
 - ① Make sure the safety of all systems related to PISCO products before maintenance.
 - ② Restart of operation after maintenance shall be proceeded with care after ensuring safety of the system by preventive measures against unexpected movements of machines and devices where pneumatic equipment is used.
 - ③ Keep enough space for maintenance when designing a circuit.
12. Take safety measures such as providing a protection cover if there is a risk of causing damages or fires on machine / facilities by a fluid leakage.

⚠ Caution

1. Remove dusts or drain before piping. They may get into the peripheral machine / facilities and cause malfunction.
2. When inserting an ultra-soft tube into push-in fitting, make sure to place an Insert Ring into the tube edge. There is a risk of causing the escape of tube and a fluid leakage without using an Insert Ring.
3. The product incorporating NBR as seal rubber material has a risk of malfunction caused by ozone crack. Ozone exists in high concentrations in static elimination air, clean-room, and near the high-voltage motors, etc. As a countermeasure, material change from NBR to HNBR or FKM is necessary. Consult with PISCO for more information.
4. Special option "Oil-free" products may cause a very small amount of a fluid leakage. When a fluid medium is liquid or the products are required to be used in harsh environments, contact us for further information.
5. In case of using non-PISCO brand tubes, make sure the tolerance of the outer tube diameter is within the limits of Table 1.

● Table 1. Tube O.D. Tolerance

mm size	Nylon tube	Polyurethane tube	inch size	Nylon tube	Polyurethane tube
ø1.8mm	—	± 0.05mm	ø1/8	± 0.1mm	± 0.15mm
ø3mm	—	± 0.15mm	ø5/32	± 0.1mm	± 0.15mm
ø4mm	± 0.1mm	± 0.15mm	ø3/16	± 0.1mm	± 0.15mm
ø6mm	± 0.1mm	± 0.15mm	ø1/4	± 0.1mm	± 0.15mm
ø8mm	± 0.1mm	± 0.15mm	ø5/16	± 0.1mm	± 0.15mm
ø10mm	± 0.1mm	± 0.15mm	ø3/8	± 0.1mm	± 0.15mm
ø12mm	± 0.1mm	± 0.15mm	ø1/2	± 0.1mm	± 0.15mm
ø16mm	± 0.1mm	± 0.15mm	ø5/8	± 0.1mm	± 0.15mm

6. Instructions for Tube Insertion

- ① Make sure that the cut end surface of the tube is at right angle without a scratch on the surface and deformations.
- ② When inserting a tube, the tube needs to be inserted fully into the push-in fitting until the tubing edge touches the tube end of the fitting as shown in the figure below. Otherwise, there is a risk of leakage.

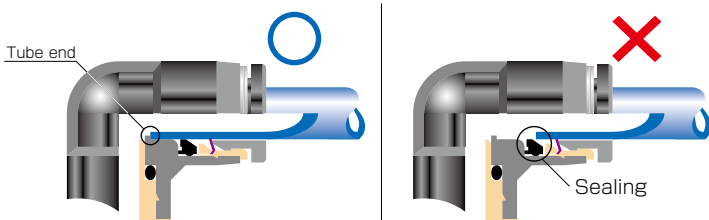

Tube is not fully inserted up to tube end.

- ③ After inserting the tube, make sure it is inserted properly and not to be disconnected by pulling it moderately.
- ※ When inserting tubes, Lock-claws may be hardly visible in the hole, observed from the front face of the release-ring. But it does not mean the tube will surely escape. Major causes of the tube escape are the followings;
- ① Shear drop of the lock-claws edge
 - ② The problem of tube diameter (usually small)
- Therefore, follow the above instructions from ① to ③, even lock-claws is hardly visible.

7. Instructions for Tube Disconnection

- ① Make sure there is no air pressure inside of the tube, before disconnecting it.
- ② Push the release-ring of the push-in fitting evenly and deeply enough to pull out the tube toward oneself. By insufficient pushing of the release-ring, the tube may not be pulled out or damaged by scratch, and tube shavings may remain inside of the fitting, which may cause the leakage later.

8. Instructions for Installing a fitting

- ① When installing a fitting, use proper tools to tighten a hexagonal-column or an inner hexagonal socket. When inserting a hex key into the inner hexagonal socket of the fitting, be careful so that the tool does not touch lock-claws. The deformation of lock-claws may result in a poor performance of systems or an escape of the tube.
- ② Refer to Table 2 which shows the recommended tightening torque. Do not exceed these limits to tighten a thread. Excessive tightening may break the thread part or deform the gasket and cause a fluid leakage. Tightening thread with tightening torque lower than these limits may cause a loosened thread or a fluid leakage.
- ③ Adjust the tube direction while tightening thread within these limits, since some PISCO products are not rotatable after the installation.

● Table 2: Recommended tightening torque / Sealock color / Gasket materials

Thread type	Thread size	Tightening torque	Sealock color	Gasket materials
Metric thread	M3 × 0.5	0.7N·m	—	SUS304 NBR
	M5 × 0.8	1.0 ~ 1.5N·m		
	M6 × 1	2 ~ 2.7N·m		
	M3 × 0.5	0.5 ~ 0.6N·m		POM
	M5 × 0.8	1 ~ 1.5N·m		
	M6 × 0.75	0.8 ~ 1N·m		
Taper pipe thread	M8 × 0.75	1 ~ 2N·m	White	—
	R1/8	7 ~ 9N·m		
	R1/4	12 ~ 14N·m		
	R3/8	22 ~ 24N·m		
Unified thread	R1/2	28 ~ 30N·m	—	SUS304, NBR
	No.10-32UNF	1.0 ~ 1.5N·m		
National pipe thread taper	1/16-27NPT	7 ~ 9N·m	White	—
	1/8-27NPT	7 ~ 9N·m		
	1/4-18NPT	12 ~ 14N·m		
	3/8-18NPT	22 ~ 24N·m		
	1/2-14NPT	28 ~ 30N·m		

※ These values may differ for some products. Refer to each specification as well.

9. Instructions for removing a fitting

- ① When removing a fitting, use proper tools to loosen a hexagonal-column or an inner hex bolt.
- ② Remove the sealant stuck on the mating equipment. The remained sealant may get into the peripheral equipment and cause malfunctions.

10. Arrange piping avoiding any load on fittings and tubes such as twist, tensile, moment load, shaking and physical impact. These may cause damages to fittings, tube deformations, bursting and the escape of tubes.

Common Safety Instructions for Fittings

Before selecting or using PISCO products, read the following instructions. Read the detailed instructions for individual series as well as the instructions below.

Warning

1. Do not use fittings with fluid medium other than air or water. (Water can be used with some series.) Contact us for using other kind of fluid medium except air and water.
2. Do not use fittings except Anti-spatter, Brass and Brass Compression Fitting series in a place where the flame and weld spatter is produced. There is a risk of causing fire by sparks.
3. As for applications where threads or tubes swing / rotate, use Rotary Joints, High Rotary Joints or Multi-Circuit Rotary Block only. The other PISCO products can be damaged in these applications.
4. Use only Die Temperature Control Fitting Series, Tube Fitting Stainless SUS316 Series, Tube Fitting Stainless SUS316 Compression Fitting Series or Tube Fitting Brass Series under the condition of over 60°C (140° F) water or thermal oil. Other PISCO products can be damaged by heat and hydrolysis under the condition above.
5. As for the condition required to dissipate static electricity or provide an antistatic performance, use EG Series fitting and antistatic products only, and do not use other PISCO products. There is a risk that static electricity can cause system defects or failures.
6. Avoid any load on PISCO products, such as a tensile strength, twisting and bending. Otherwise, there is a risk of causing damage to the products.

⚠ Caution

1. In case of using non-PISCO brand tubes, make sure the tolerance of the outer tube diameter is within the following limits of Table 1.

● Table 1. Tube O.D. Tolerance

mm size	Nylon tube	Urethane tube	inch size	Nylon tube	Urethane tube
ø1.8mm	—	± 0.05mm	ø1/8	± 0.1mm	± 0.15mm
ø3mm	—	± 0.15mm	ø5/32	± 0.1mm	± 0.15mm
ø4mm	± 0.1mm	± 0.15mm	ø3/16	± 0.1mm	± 0.15mm
ø6mm	± 0.1mm	± 0.15mm	ø1/4	± 0.1mm	± 0.15mm
ø8mm	± 0.1mm	± 0.15mm	ø5/16	± 0.1mm	± 0.15mm
ø10mm	± 0.1mm	± 0.15mm	ø3/8	± 0.1mm	± 0.15mm
ø12mm	± 0.1mm	± 0.15mm	ø1/2	± 0.1mm	± 0.15mm
ø16mm	± 0.1mm	± 0.15mm	ø5/8	± 0.1mm	± 0.15mm

2. Instructions for Tube Insertion

- ① Make sure that the cut end surface of the tube is at right angle without a scratch on the tube surface and deformations.
- ② When inserting a tube, the tube needs to be inserted fully into the push-in fitting until the tubing edge touches the tube end of the fitting as shown in the figure below. Otherwise, there is a risk of leakage.

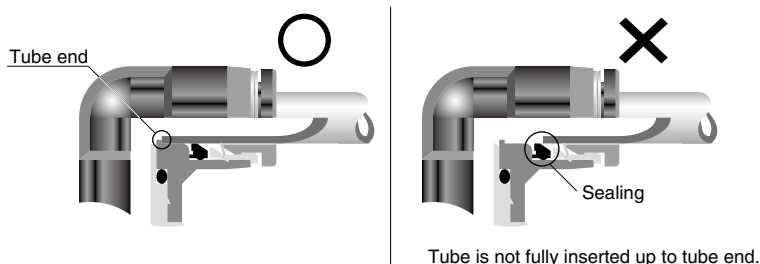

- ③ After inserting the tube, make sure it is inserted properly and not to be disconnected by pulling it moderately.

3. Instructions for Tube Disconnection

- ① Make sure there is no air pressure inside of the tube, before disconnecting it.
- ② Push the release-ring of the push-in fitting evenly and deeply enough to pull out the tube toward oneself. By insufficient pushing of the release-ring, the tube may not be pulled out or damaged by scratch, and tube shavings may remain inside of the fitting, which may cause the leakage later.

4. Instructions for Installing a fitting

- ① When installing a fitting, use proper tools to tighten a hexagonal-column or an inner hexagonal socket. When inserting a hex key into the inner hexagonal socket of the fitting, be careful so that the tool does not touch lock-claws. The deformation of lock-claws may result in a poor performance of systems or an escape of the tube.
- ② Refer to Table 2 which shows the recommended tightening torque. Do not exceed these limits to tighten a thread. Excessive tightening may break the thread part or deform the gasket and cause a fluid leakage. Tightening thread with tightening torque lower than these limits may cause a loosened thread or a fluid leakage.
- ③ Adjust the tube direction while tightening thread within these limits, since some PISCO products are not rotatable the installation.

● Table 2: Recommended tightening torque / Sealock color / Gasket materials

Thread type	Thread size	Tightening torque	Sealock color	Gasket materials
Metric thread	M3 × 0.5	0.7N·m	—	SUS304 NBR
	M5 × 0.8	1.0 ~ 1.5N·m		
	M6 × 1	2 ~ 2.7N·m		
	M3 × 0.5	0.5 ~ 0.6N·m		POM
	M5 × 0.8	1 ~ 1.5N·m		
	M6 × 0.75	0.8 ~ 1N·m		
	M8 × 0.75	1 ~ 2N·m		
Taper pipe thread	R1/8	7 ~ 9N·m	White	—
	R1/4	12 ~ 14N·m		
	R3/8	22 ~ 24N·m		
	R1/2	28 ~ 30N·m		
Unified thread	No.10-32UNF	1.0 ~ 1.5N·m	—	SUS304, NBR
National pipe thread taper	1/16-28NPT	7 ~ 9N·m	White	—
	1/8-27NPT	7 ~ 9N·m		
	1/4-18NPT	12 ~ 14N·m		
	3/8-18NPT	22 ~ 24N·m		
	1/2-14NPT	28 ~ 30N·m		

※. These values may differ for some products. Refer to each specification as well

5. Instructions for removing a fitting

- ① When removing a fitting, use proper tools to loosen a hexagonal-column or an inner hexagonal socket.
- ② Remove the sealant stuck on the mating equipment. The remained sealant may get into the peripheral equipment and cause malfunctions.

6. Arrange piping avoiding any load on fittings and tubes such as twist, tensile, moment load, shaking and physical impact. These may cause damages to fittings, tube deformations, bursting and the escape of tubes.