

Miniature Pressure Regulator

Pressure reducing valve with Push-Lock knob

NEW



Lighter
Easier

Pushing to lock style makes it easier

Setting and Adjusting

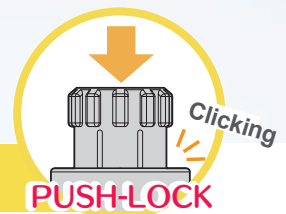

Once it is set, the set pressure will not change due to vibrations

- ▶ New design enables about **1.3** times higher flow than the previous models. The set pressure fluctuation range reduced.

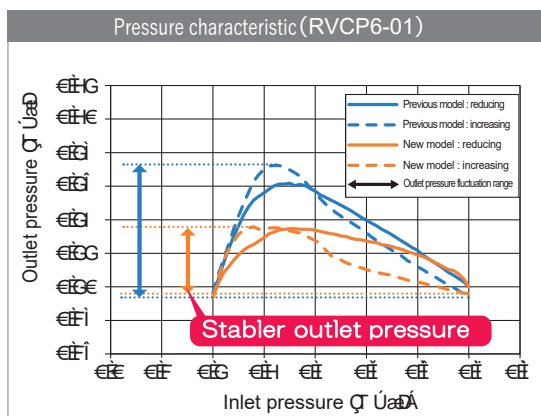

※ Inlet pressure : 0.7MPa, Outlet pressure : set at 0.2MPa
Then, change the inlet pressure to 0.7MPa → 0.2MPa → 0.7MPa

- ▶ Comes with a **relief valve** for easy adjustments
- ▶ **Free reverse flow**
It can be used as a reverse flow regulator by installing it between solenoid valve and actuator
Unrestricted reverse flow for quick exhausting
- ▶ Certain models come with **Pressure Gauge**

Model Designation (Example)

RV **C** **P** **1/4** - **N1U**

③. Thread size or Tubing O.D. (In case of In-Line model like U and UM, specify the tubing O.D. code from ②)

	Unified thread	Tapered pipe thread			Metric thread	
Code	U10U	N1U	N2U	O1	O2	M5
Size	10-32UNF	1/8NPT	1/4NPT	R1/8	R1/4	M5×0.8

※ The unit of wrench size is inch (the code suffix is "U").

②. Tubing O.D.

	Inch			Metric		
Code	5/32	1/4	5/16	4	6	8
Tubing O.D.	5/32"	1/4"	5/16"	ø4	ø6	ø8

Push to Lock type

①: Type

Code	Type
C	Right angle
CM	Right angle with Gauge
U	Inline
UM	Inline with Gauge

Pressure Regulator

Specification

Fluid medium	Air	
Service pressure range	0 ~ 145psi	(0 ~ 1.0MPa)
Setting range	14.5 ~ 116psi	(0.1 ~ 0.8MPa)
Gauge display range	0 ~ 116psi	(0 ~ 0.8MPa)
Tolerance (Gauge)	± 5% (F.S)	
Service temperature	32 ~ 140°F (0 ~ 60°C) (no freezing)	

※) Imperial model comes with a gauge indicating in psi

Structure

■ Structure : Elbow model RVCP

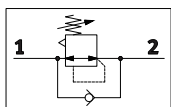

Symbol

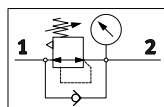

Symbol for with a gauge

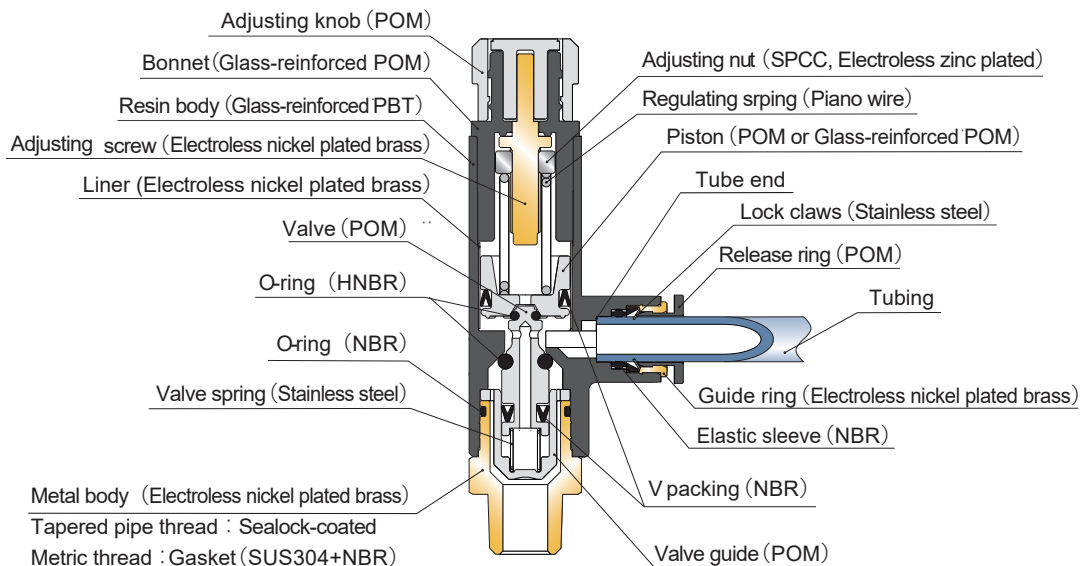

Safety instructions

⚠ Warning

1. Do not use Pressure regulator when there are large fluctuation in the secondary pressure or the pressure exceeds the adjusted range. Malfunctions may occur since it is not designed as a relief valve. In such case, install a safety device in the system to avoid malfunctions.

⚠ Caution

1. In order to adjust the pressure, set the pressure at a certain level, then increase (turn knob clockwise) the input pressure. Setting the pressure, then decreasing (turn knob counter-clockwise) the input pressure is not so accurate.
2. Do not turn the adjusting knob excessively counter-clockwise from the position of fully-open, or clockwise from the position of fully-closed. Doing so may cause damages to the adjusting knob and the body or unsmoothing the knob rotation.
3. Pulling the adjusting knob to unlock and pushing it to lock. Make sure it is in the locking position. Otherwise, the set pressure may change during usage.
4. When pushing down on the adjusting knob, it could sit in the middle position between 'locked' and 'released'. In this situation, the valve is not locked. Please make sure the adjusting knob is fully pushed in the 'locked' position.
5. Do not turn the knob when it is in the pushed position. Otherwise it may cause a damage on the locking mechanism.
6. The direction of gauge can be changed at your favorite. Do not apply excessive force on the gauge cap. Otherwise it may cause a damage to the gauge and the display failure. Please turn it by gripping the bottom portion of the gauge.
7. Tolerance of regulator gauge is $\pm 5\%$ (F.S.). In case further accuracy is required, use an accurate gauge in addition.
8. Sympathetic vibration can be generated by exhausting open-air from the secondary side and it can cause an internal damage of Regulator. Avoid open-air exhaustion from the secondary side for a long time.

How to adjust the pressure

1. Pressure adjustment

When the pressure adjustment is needed, pull the adjusting knob and rotate it to adjust the pressure.
Do not apply excessive force on the knob. Damages may occur.

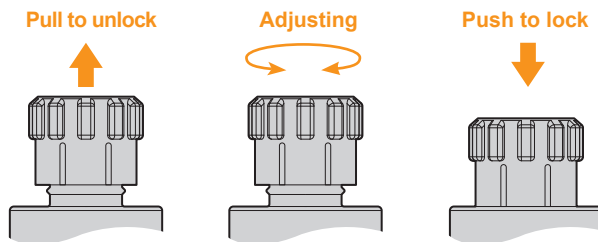

2. Increasing pressure

Turn the adjusting knob clockwise from the full open position to increase the pressure.
When it comes to the desired pressure, push the knob to lock up the pressure.

3. Deducing pressure

When turning the knob too much (the pressure rises higher), turn the knob counter-clockwise to reduce the pressure.

Then, take a same method of "2. Increasing pressure" to set the pressure.
Make sure pushing the knob to prevent the set pressure from changing.

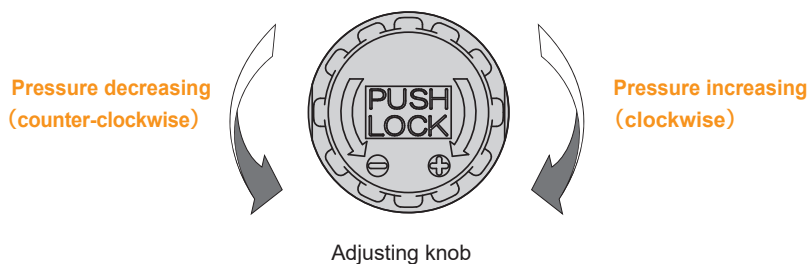

Dimensions

RVCP Right Angle type



Straight thread

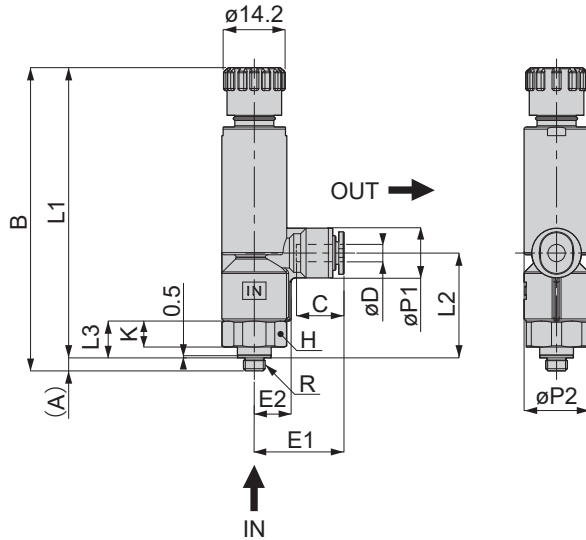

Tapered pipe thread

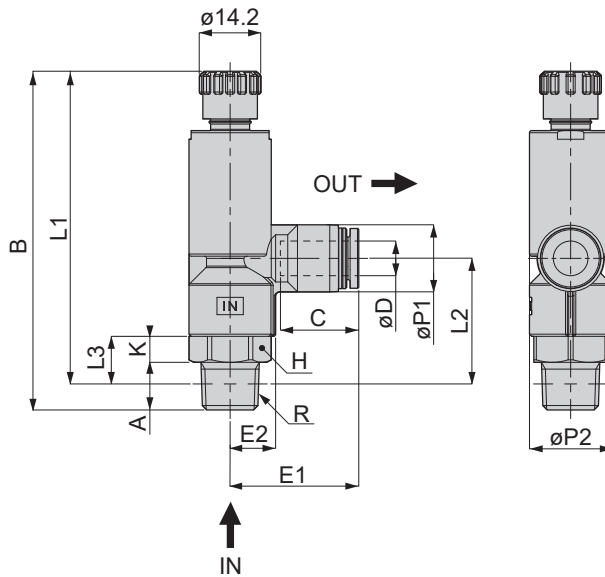

Unit : mm

Model	Tubing O.D. ϕD	R	A	B		L1		L2	L3	$\phi P1$	$\phi P2$	Tube End C	E1	E2	Hex. H	K	Release-ring			Weight (g)	Price (\$)
				max.	min.	max.	min.										ϕZ	X	Y		
RVCP5/32-U10U	5/32"	10-32UNF	3	70	67.4	67	64.4	24.2	8.5	11.5	15	11	20.7	8.5	9/16"	6	-	9.8	7.8	25	22.73
RVCP5/32-N1U		1/8NPT	8	71.5	68.9	67.5	64.9	24.7	9												
RVCP3/16-U10U	3/16"	10-32UNF	3	70	67.4	67	64.4	24.2	8.5	11.5	15	11.7	21.2	8.5	9/16"	6	-	11.8	9.8	26	24.55
RVCP3/16-N1U		1/8NPT	8	71.5	68.9	67.4	64.8	24.6	8.9												
RVCP3/16-N2U	3/16"	1/4NPT	11	78.2	75.6	72.4	69.8	29.2	11.2	15.5	19	17.4	30.2	10.5	11/16"	6	11.8	-	-	47	30.45
RVCP1/4-U10U		10-32UNF	3	70	67.4	67	64.4	24.2	8.5												
RVCP1/4-N1U	1/8NPT	8	71.5	68.9	67.4	64.8	24.6	8.9	5	28.00											
RVCP1/4-N2U	1/4"	1/4NPT	11	78.2	75.6	72.4	69.8	29.2	11.2	15.5	19	17	29.8	10.5	11/16"	6	11.8	-	-	47	30.45
RVCP5/16-N1U		1/8NPT	8	71.5	68.9	67.4	64.8	24.6	8.9												
RVCP5/16-N2U	1/4NPT	11	78.2	75.6	72.4	69.8	29.2	11.2	19	47	32.27										
RVCP4-M5	4	M5x0.8	3	70	67.4	67	64.4	24.2	8.5	11.5	15	11	20.7	8.5	14	6	-	9.8	7.8	26	22.73
RVCP4-01		R1/8	8	71.5	68.9	67.5	64.9	24.7	9												
RVCP6-M5	6	M5x0.8	3	70	67.4	67	64.4	24.2	8.5	11.5	15	11.6	21.1	8.5	14	6	-	11.8	9.8	26	24.55
RVCP6-01		R1/8	8	71.5	68.9	67.5	64.9	24.7	9												
RVCP6-02	6	R1/4	11	78.2	75.6	72.2	69.6	29	11	15.5	19	17	29.8	10.5	17	6	11.8	-	-	46	30.45
RVCP8-01		R1/8	8	71.5	68.9	67.5	64.9	24.7	9												
RVCP8-02	R1/4	11	78.2	75.6	72.2	69.6	29	11	19	46	32.27										

※) L1, L2 dimensions are of the ones after installation.

RVCMP Right Angle type with Gauge



Straight thread

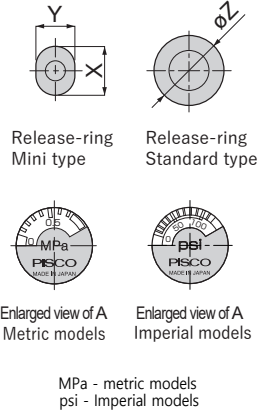
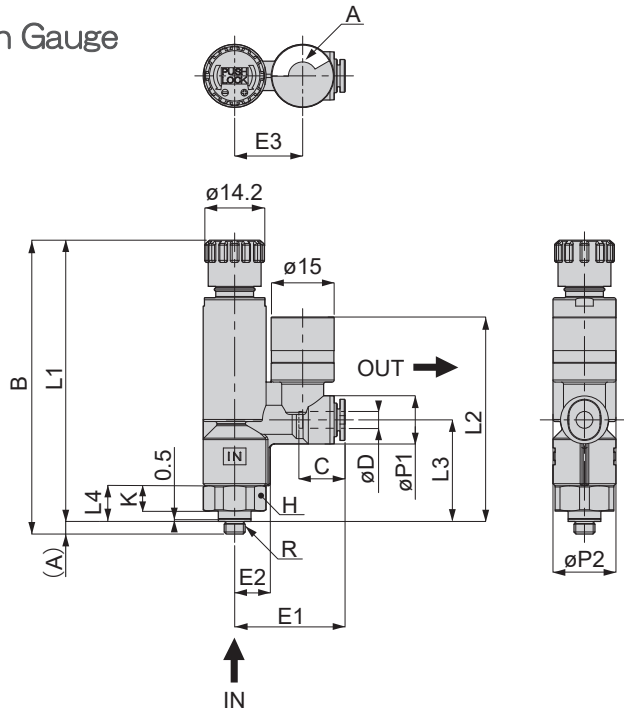

Tapered pipe thread

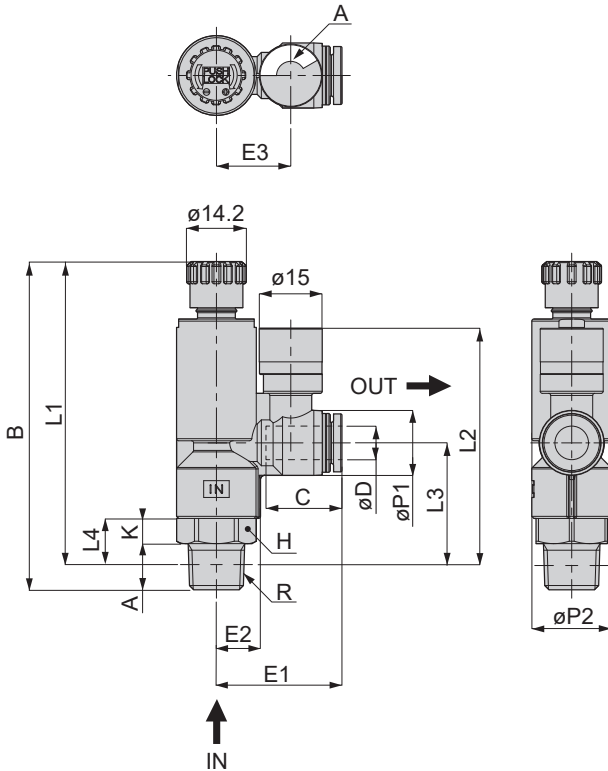

Unit : mm

Model	Tube O.D. øD	R	A	B		L1		L2	L3	L4	øP1	øP2	Tube End C	E1	E2	E3	Hex. H	K	Release-ring			Weight (g)	Price (\$)
				max.	min.	max.	min.												øZ	X	Y		
RVCMP5/32-U10U	5/32"	10-32UNF	3	70	67.4	67	64.4	48.7	24.2	8.5	11.5	15	11	26.3	8.5	16.2	9/16"	6	-	9.8	7.8	28	36.36
RVCMP5/32-N1U		1/8NPT	8	71.5	68.9	67.4	64.8	49.1	24.6	8.9													
RVCMP1/4-N1U	1/4"	1/8NPT	8	71.5	68.9	67.4	64.8	49.1	24.6	8.9	11.5	15	11.4	26.9	8.5	16.2	9/16"	5	-	11.8	9.8	29	41.64
RVCMP1/4-N2U		1/4NPT	11	78.2	75.6	72.4	69.8	56.5	29.2	11.2													
RVCMP5/16-N1U	5/16"	1/8NPT	8	71.5	68.9	67.4	64.8	51.9	24.6	8.9	15.5	15	18.1	28.4	8.5	16.2	9/16"	5	13.8	-	-	32	43.45
RVCMP5/16-N2U		1/4NPT	11	78.2	75.6	72.4	69.8	56.5	29.2	11.2													
RVCMP4-M5	4	M5x0.8	3	70	67.4	67	64.4	48.7	24.2	8.5	11.5	15	11	26.3	8.5	16.2	14	6	-	9.8	7.8	29	36.36
RVCMP4-01		R1/8	8	71.5	68.9	67.5	64.9	49.2	24.7	9													
RVCMP6-M5	6	M5x0.8	3	70	67.4	67	64.4	48.7	24.2	8.5	11.5	15	11.6	26.7	8.5	16.2	14	6	-	11.8	9.8	29	38.18
RVCMP6-01		R1/8	8	71.5	68.9	67.5	64.9	49.2	24.7	9													
RVCMP6-02	6	R1/4	11	78.2	75.6	72.2	69.6	56.3	29	11	15.5	19	17	30	10.5	17.7	17	6	11.8	-	-	49	44.09
RVCMP8-01		R1/8	8	71.5	68.9	67.5	64.9	52	24.7	9													
RVCMP8-02	8	R1/4	11	78.2	75.6	72.2	69.6	56.3	29	11	15.5	19	18.1	29.9	10.5	17.7	17	6	13.8	-	-	49	45.91

※) L1, L2 dimensions are of the ones after installation.

RVUP In-Line type

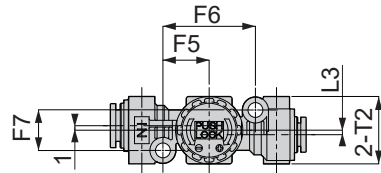

IN → OUT →

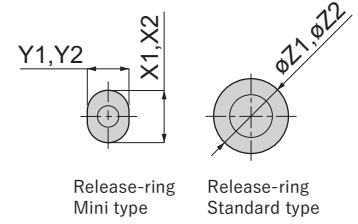
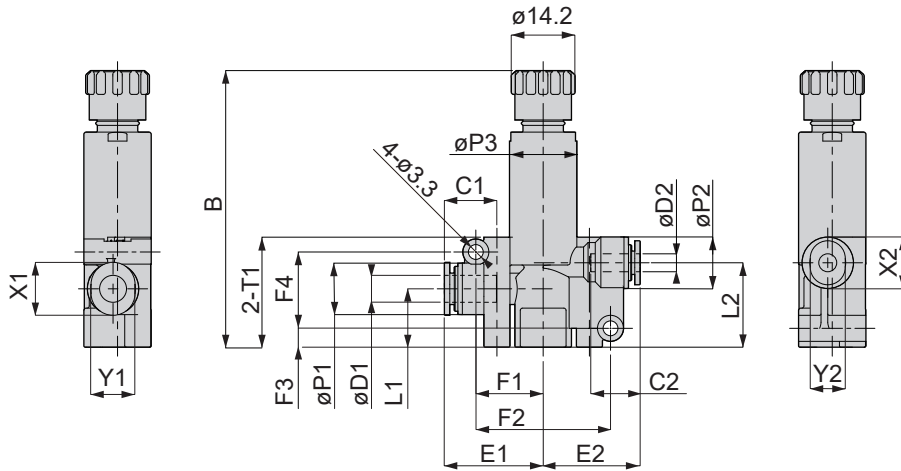

Unit : mm

Model	Tubing O.D. øD1	Tubing O.D. øD2	B		L1	L2	L3	øP1	øP2	øP3	Tube End C1	Tube End C2	E1	E2
			max.	min.										
RVUP5/32-5/32	5/32	5/32	61.6	59	13	18.8	1	11.5	11.5	15	11	11	21.6	21.6
RVUP1/4-5/32	1/4	5/32	61.6	59	13	18.8	1	11.5	11.5	15	11.4	11	22.2	21.6
RVUP1/4-1/4		1/4										11.4		
RVUP5/16-1/4	5/16	1/4	65.7	63.1	15	22.5	-	15.5	15.5	19	18.1	17	28.6	28.7
RVUP5/16-5/16		5/16										18.1		
RVUP4-4	4	4	61.6	59	13	18.8	1	11.5	11.5	15	11	11	21.6	21.6
RVUP6-4	6	4	61.6	59	13	18.8	1	11.5	11.5	15	11.6	11	22	21.6
RVUP6-6		6										11.6		
RVUP8-6	8	6	65.7	63.1	15	22.5	-	15.5	15.5	19	18.1	17	28.6	28.7
RVUP8-8		8										18.1		

Model	F1	F2	F3	F4	F5	F6	F7	T1	T2	Release-ring						Weight (g)	Price (\$)
										øZ1	X1	Y1	øZ2	X2	Y2		
RVUP5/32-5/32	15	30	4.2	17	10.3	20.6	9	24.5	15	-	9.8	7.8	-	9.8	7.8	19	26.18
RVUP1/4-5/32	15	30	4.2	17	10.3	20.6	9	24.5	15	-	11.8	9.8	-	9.8	7.8	20	28.00
RVUP1/4-1/4													11.8	9.8			
RVUP5/16-1/4	19.8	39.6	4	21.5	11.7	23.4	13	28.4	19	13.8	-	-	11.8	-	-	32	32.27
RVUP5/16-5/16													13.8				
RVUP4-4	15	30	4.2	17	10.3	20.6	9	24.5	15	-	9.8	7.8	-	9.8	7.8	19	26.18
RVUP6-4	15	30	4.2	17	10.3	20.6	9	24.5	15	-	11.8	9.8	-	9.8	7.8	20	28.00
RVUP6-6													11.8	9.8			
RVUP8-6	19.8	39.6	4	21.5	11.7	23.4	13	28.4	19	13.8	-	-	11.8	-	-	32	32.27
RVUP8-8													13.8				

※) The dimensions of the mounting holes are exact same as the previous models

RVUMP Inline type with Gauge

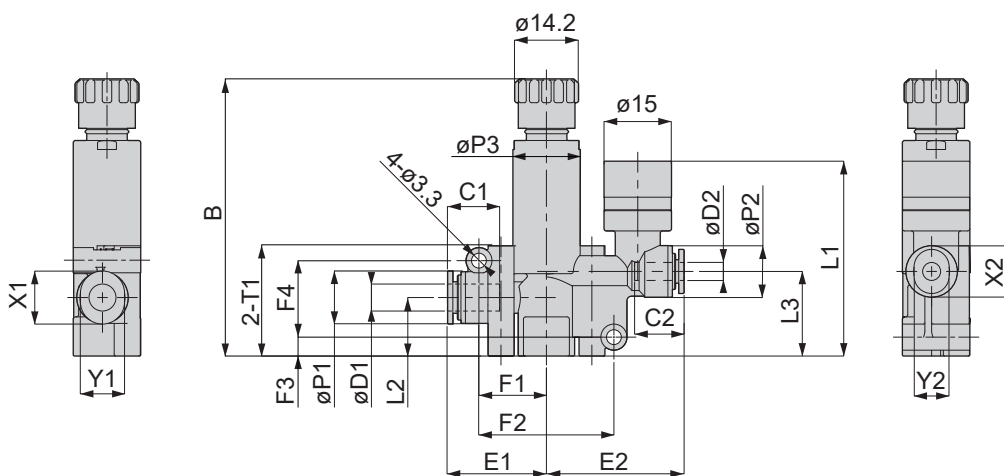
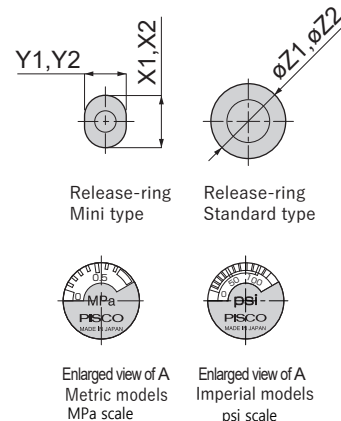
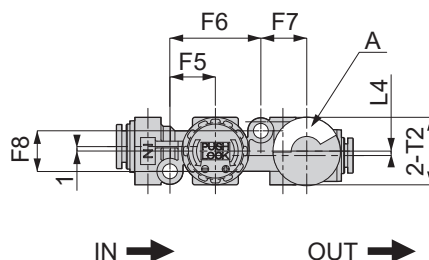

Unit : mm

Model	Tubing O.D. øD1	Tubing O.D. øD2	B		L1	L2	L3	L4	øP1	øP2	øP3	Tube End C1	Tube End C2	E1	E2
			max.	min.											
RVUMP5/32-5/32	5/32	5/32	61.6	59	43.3	13	18.8	1	11.5	11.5	15	11	11	21.6	30.6
RVUMP1/4-5/32	1/4	5/32	61.6	59	43.3	13	18.8	1	11.5	11.5	15	11.4	11	22.2	30.6
RVUMP1/4-1/4		1/4											11.4		
RVUMP5/16-1/4	5/16	1/4	65.7	63.1	49.8	15	22.5	-	15.5	15.5	19	18.1	17	28.6	33
RVUMP5/16-5/16		5/16											18.1		
RVUMP4-4	4	4	61.6	59	43.3	13	18.8	1	11.5	11.5	15	11	11	21.6	30.6
RVUMP6-4	6	4	61.6	59	43.3	13	18.8	1	11.5	11.5	15	11.6	11	22	30.6
RVUMP6-6		6											11.6		
RVUMP8-6	8	6	65.7	63.1	49.8	15	22.5	-	15.5	15.5	19	18.1	17	28.6	33
RVUMP8-8		8											18.1		

Model	F1	F2	F3	F4	F5	F6	F7	F8	T1	T2	Release-ring						Weight (g)	Price (\$)
											øZ1	X1	Y1	øZ2	X2	Y2		
RVUMP5/32-5/32	15	30	4.2	17	10.1	20.2	10.2	9	24.5	15	-	9.8	7.8	-	9.8	7.8	23	39.82
RVUMP1/4-5/32	15	30	4.2	17	10.1	20.2	10.2	9	24.5	15	-	11.8	9.8	-	9.8	7.8	23	41.64
RVUMP1/4-1/4															11.8	9.8		41.64
RVUMP5/16-1/4	19.9	39.7	4.1	21.3	11.6	23.2	9.1	13	28.4	19	13.8	-	-	11.8	-	-	36	45.91
RVUMP5/16-5/16														13.8	-	-		45.91
RVUMP4-4	15	30	4.2	17	10.1	20.2	10.2	9	24.5	15	-	9.8	7.8	-	9.8	7.8	23	39.82
RVUMP6-4	15	30	4.2	17	10.1	20.2	10.2	9	24.5	15	-	11.8	9.8	-	9.8	7.8	23	41.64
RVUMP6-6															11.8	9.8		41.64
RVUMP8-6	19.9	39.7	4.1	21.3	11.6	23.2	9.1	13	28.4	19	13.8	-	-	11.8	-	-	36	45.91
RVUMP8-8														13.8	-	-		45.91

※) The dimensions of the mounting holes are exact same as the previous models

Characteristics for Right Angle regulator (RVCP) • Right Angle regulator with Gauge (RVCMP)

■ Flow characteristics

RVCP5/32-U10U, RVCMP5/32-U10U

RVCP4-M5, RVCMP4-M5

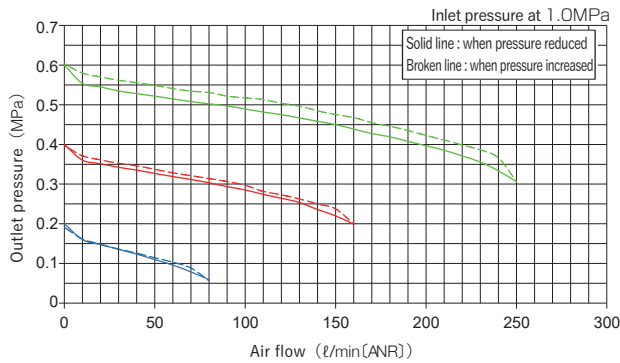

RVCP6-M5, RVCMP6-M5

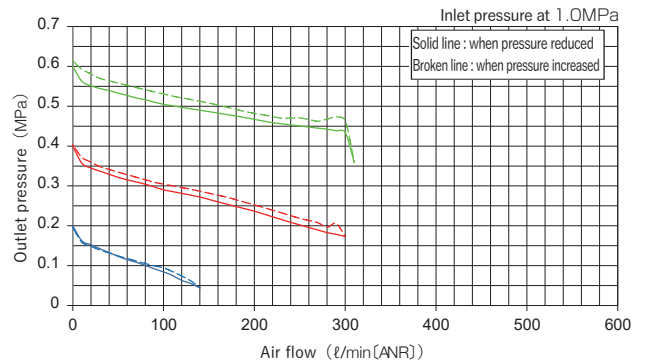

RVCP1/4-U10U

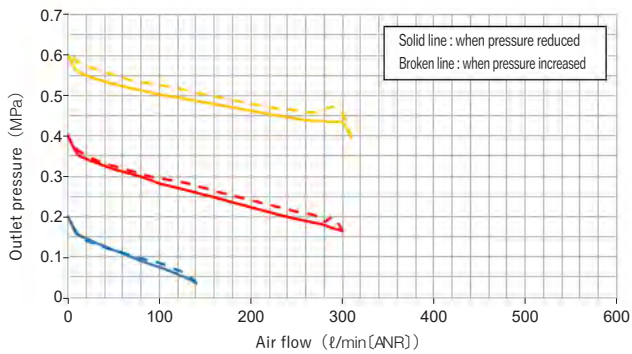

RVCP3/16-U10U

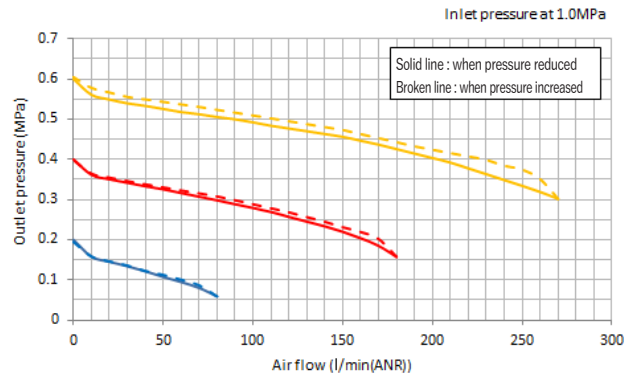

■ Pressure characteristics ※1)

RVCP5/32-U10U, RVCMP5/32-U10U

RVCP1/4-U10U, RVCMP3/16-U10U

RVCP4-M5, RVCMP4-M5

RVCP6-M5, RVCMP6-M5

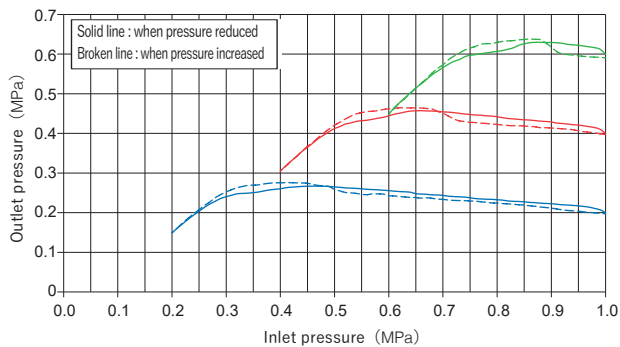

■ Free flow ※2)

RVCP5/32-U10U, RVCMP5/32-U10U

RVCP1/4-U10U, RVCMP3/16-U10U

RVCP4-M5, RVCMP4-M5

RVCP6-M5, RVCMP6-M5

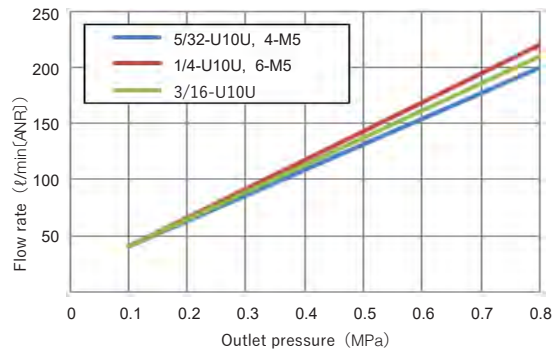

※ 1) The inlet pressure changes from 1.0MPa → Set pressure (0.2, 0.4 and 0.6MPa) → 1.0MPa

※ 2) Air flow from the outlet port to the inlet port

Flow characteristics

**RVCP5/32-N1U, RVCMP5/32-N1U
RVCP4-01, RVCMP4-01**

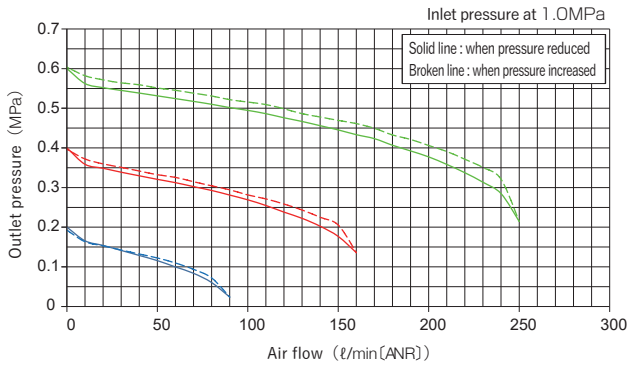

RVCP6-01, RVCMP6-01

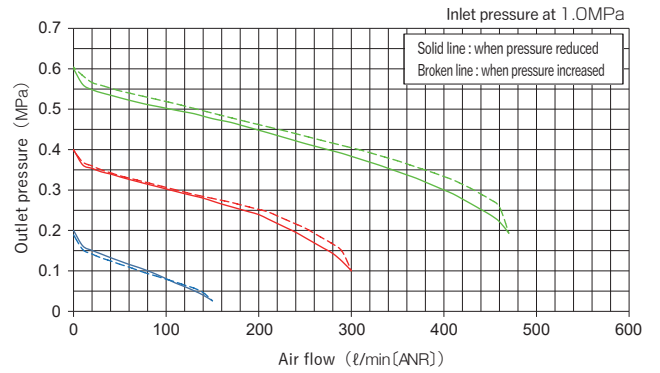

**RVCP5/16-N1U, RVCMP5/16-N1U
RVCP8-01, RVCMP8-01**

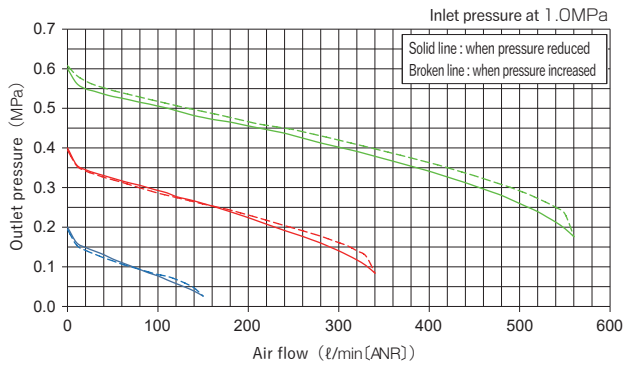

RVCP3/16-N1U

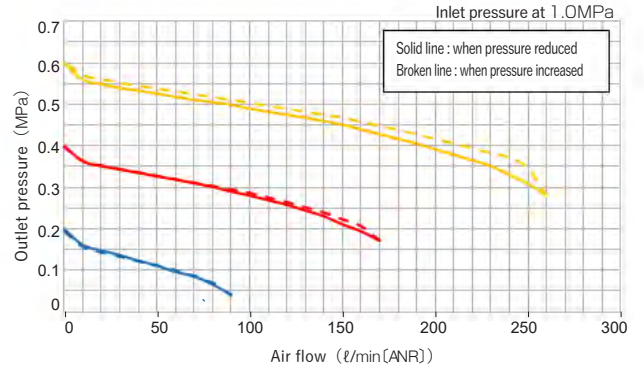

RVCP1/4-N1U, RVCMP1/4-N1U

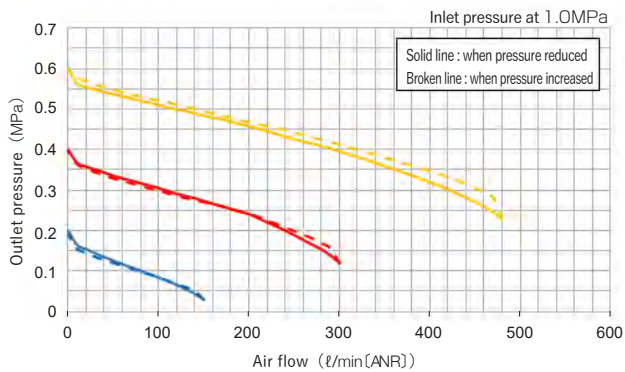

Pressure characteristics ※1)

**RVCP5/32-N1U, RVCMP5/32-N1U
RVCP1/4-N1U, RVCMP1/4-N1U, RVCP3/16-N1U
RVCP5/16-N1U, RVCMP5/16-N1U
RVCP4-01, RVCMP4-01
RVCP6-01, RVCMP6-01
RVCP8-01, RVCMP8-01**

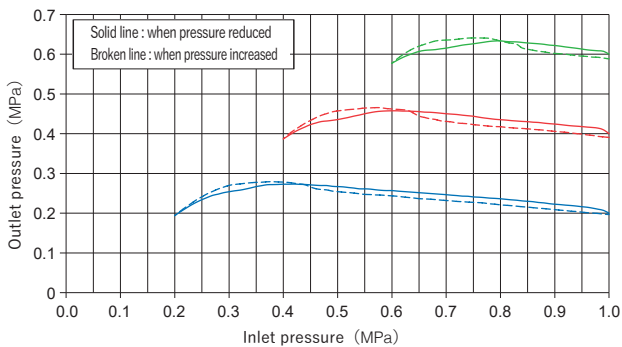

Free flow ※2)

**RVCP5/32-N1U, RVCMP5/32-N1U
RVCP1/4-N1U, RVCMP1/4-N1U, RVCP3/16-N1U
RVCP5/16-N1U, RVCMP5/16-N1U
RVCP4-01, RVCMP4-01
RVCP6-01, RVCMP6-01
RVCP8-01, RVCMP8-01**

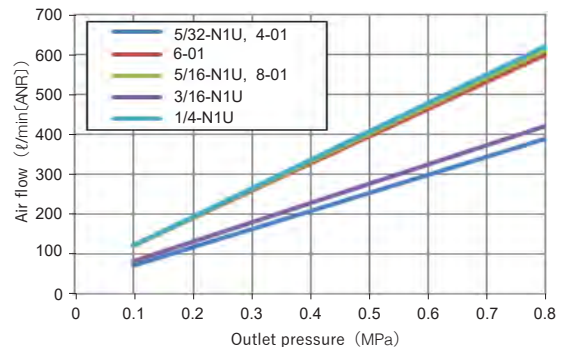

※1) The inlet pressure changes from 1.0MPa → Set pressure (0.2, 0.4 and 0.6MPa) → 1.0MPa

※2) Air flow from the outlet port to the inlet port

Flow characteristics

RVCP1/4-N2U, RVCMP1/4-N2U

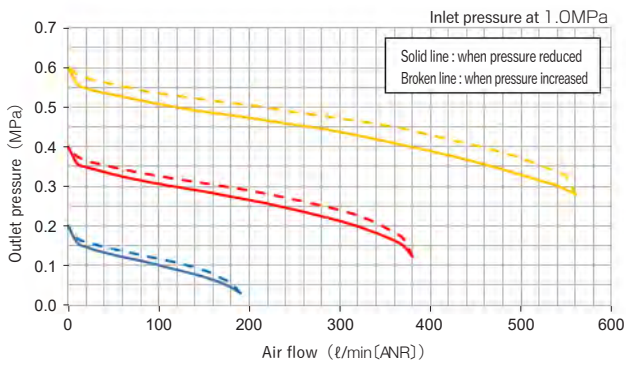

RVCP3/16-N2U

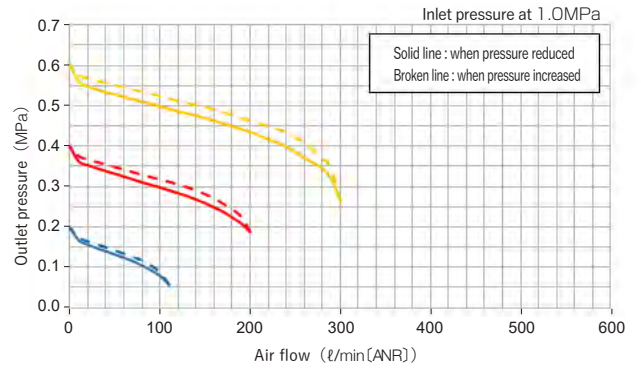

RVCP6-02, RVCMP6-02

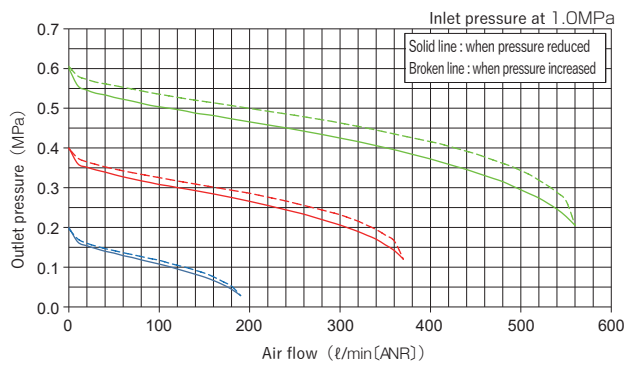

RVCP5/16-N2U, RVCMP5/16-N2U
RVCP8-02, RVCMP8-02

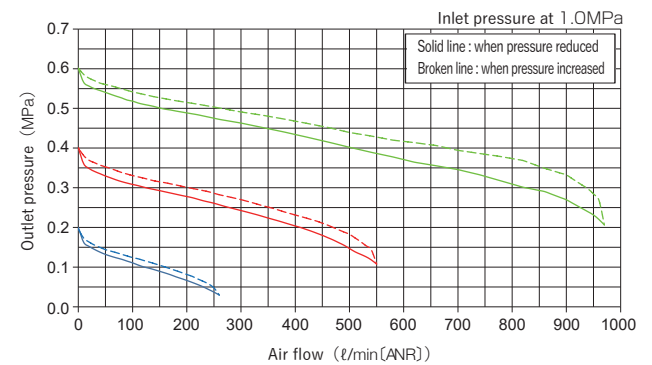

Pressure characteristics ※1)

RVCP1/4-N2U, RVCMP1/4-N2U
RVCP5/16-N2U, RVCMP5/16-N2U
RVCP6-02, RVCMP6-02
RVCP8-02, RVCMP8-02

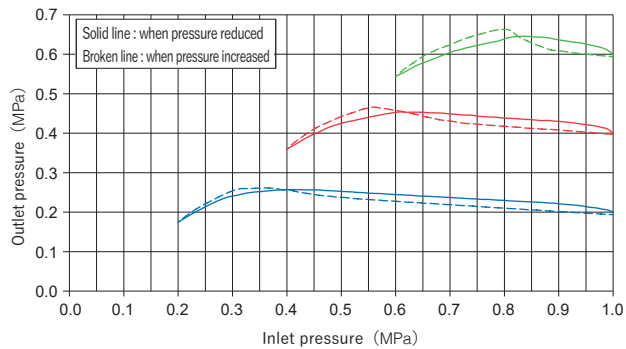

RVCP3/16-N2U

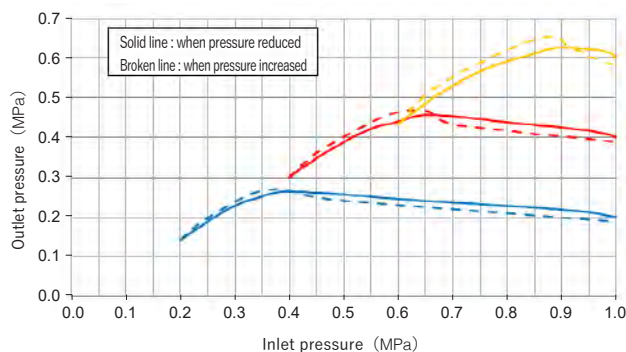

Free flow ※2)

RVCP1/4-N2U, RVCMP1/4-N2U, RVCP3/16-N2U
RVCP5/16-N2U, RVCMP5/16-N2U
RVCP6-02, RVCMP6-02
RVCP8-02, RVCMP8-02

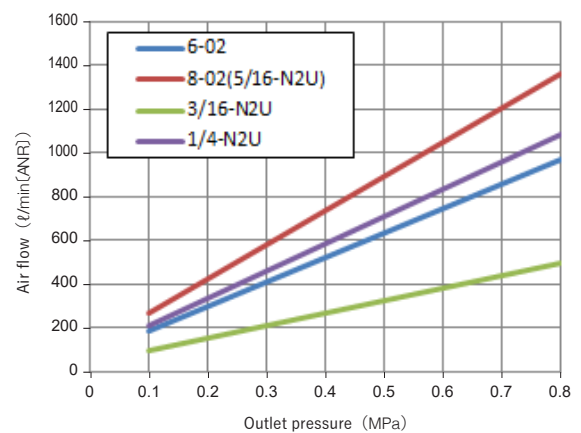

※1) The inlet pressure changes from 1.0MPa → Set pressure (0.2, 0.4 and 0.6MPa) → 1.0MPa

※2) Air flow from the outlet port to the inlet port

Characteristics of Inline regulator (RVUP) · Inline regulator with Gauge (RVUMP)

Flow characteristics

RVUP5/32-5/32, RVUP4-4, RVUMP5/32-5/32, RVUMP4-4

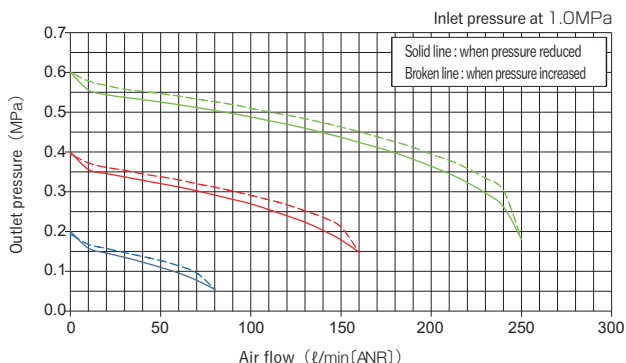

RVUP1/4-5/32, RVUMP1/4-5/32

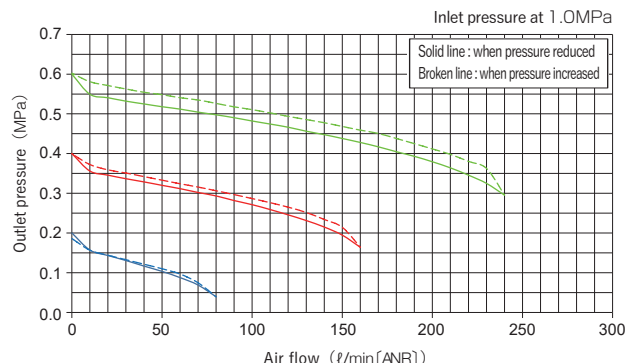

RVUP1/4-1/4, RVUMP1/4-1/4

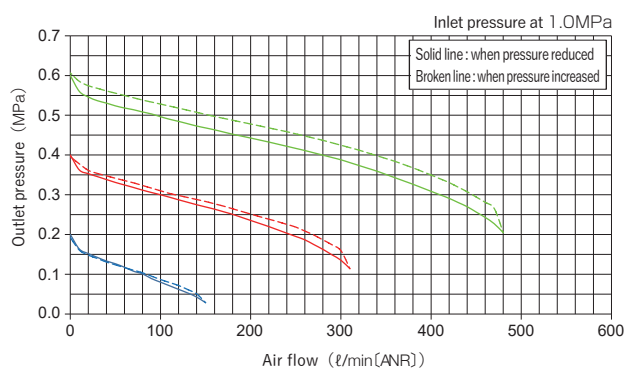

RVUP6-4, RVUMP6-4

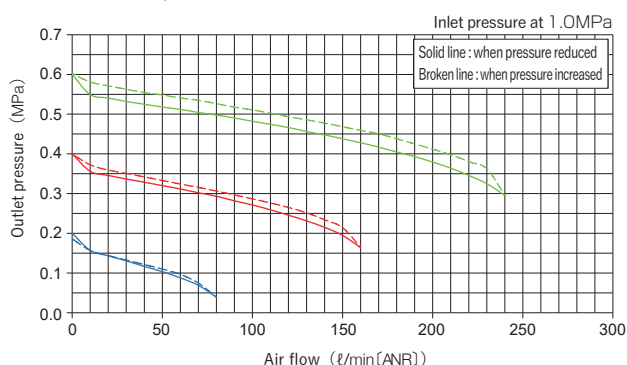

RVUP6-6, RVUMP6-6

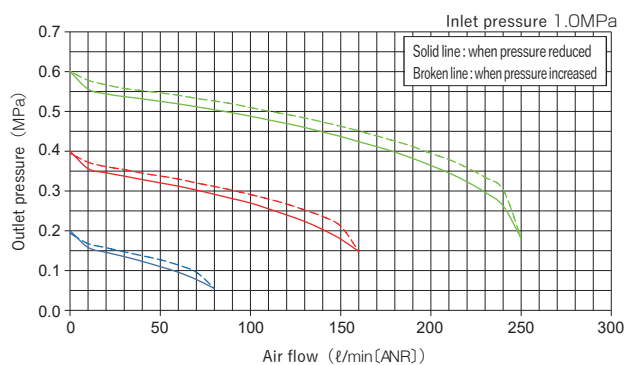

Pressure characteristics ※1)

RVUP4-4, RVUP5/32-5/32, RVUMP4-4, RVUMP5/32-5/32

RVUP6-4, RVUMP6-4, RVUP6-6, RVUMP6-6

RVUP1/4-5/32, RVUMP1/4-5/32

RVUP1/4-1/4, RVUMP1/4-1/4

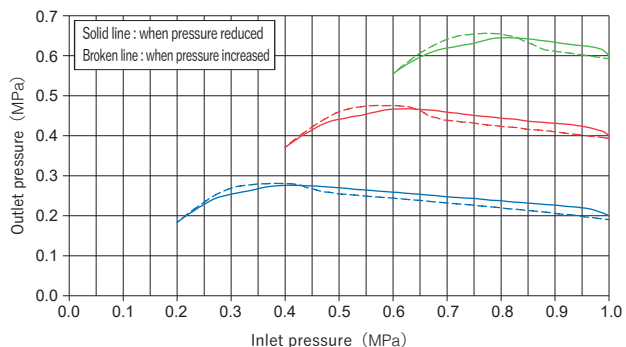

Free flow ※2)

RVUP4-4, RVUP5/32-5/32, RVUMP4-4, RVUMP5/32-5/32

RVUP6-4, RVUMP6-4, RVUP6-6, RVUMP6-6

RVUP1/4-5/32, RVUMP1/4-5/32

RVUP1/4-1/4, RVUMP1/4-1/4

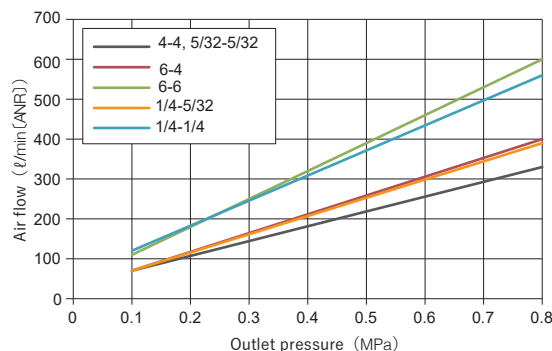

※1) The inlet pressure changes from 1.0MPa → Set pressure (0.2, 0.4 and 0.6MPa) → 1.0MPa

※2) Air flow from the outlet port to the inlet port

Flow characteristics

RVUP5/16-5/16, RVUP8-8

RVUMP5/16-5/16, RVUMP8-8

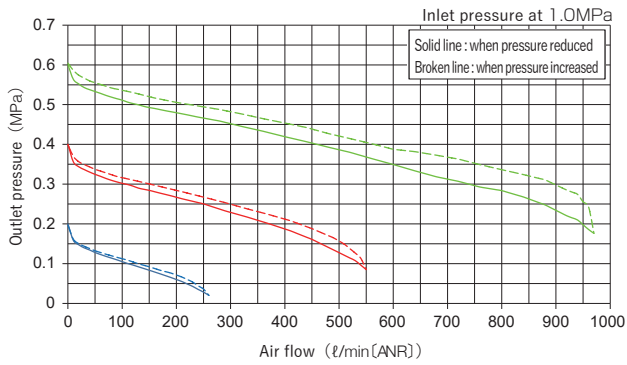

RVUP8-6, RVUMP8-6

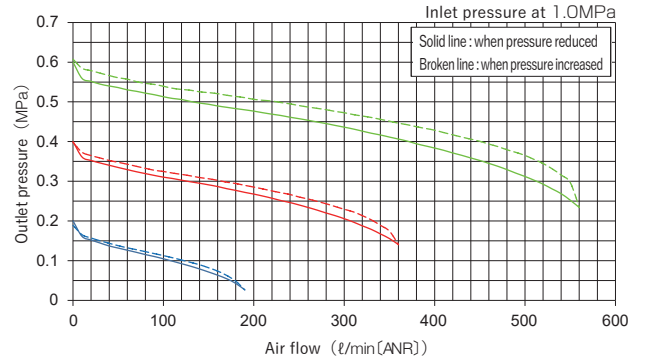

RVUP5/16-1/4, RVUMP5/16-1/4

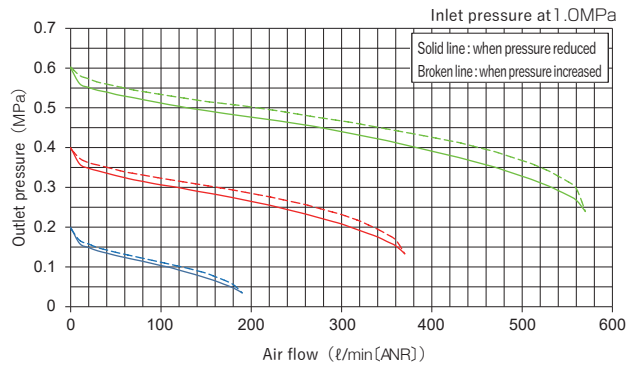

Pressure characteristics ※1)

RVUP8-6, RVUMP8-6,

RVUP8-8, RVUP5/16-5/16

RVUMP8-8, RVUMP5/16-5/16

RVUP5/16-1/4, RVUMP5/16-1/4

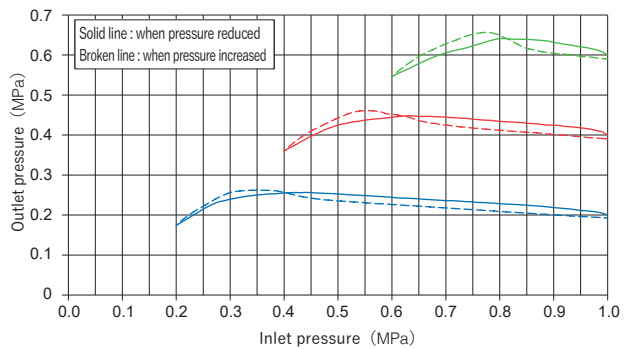

Free flow ※2)

RVUP8-6, RVUMP8-6,

RVUP8-8, RVUP5/16-5/16

RVUMP8-8, RVUMP5/16-5/16

RVUP5/16-1/4, RVUMP5/16-1/4

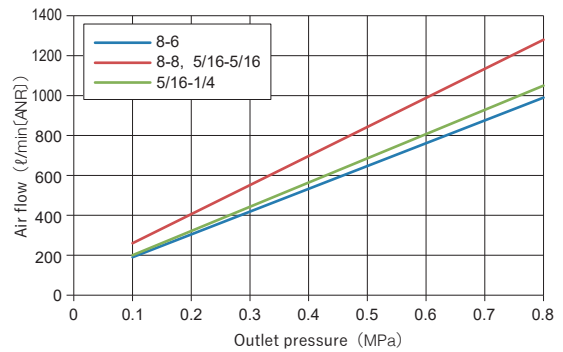

※ 1) The inlet pressure changes from 1.0MPa → Set pressure (0.2, 0.4 and 0.6MPa) → 1.0MPa

※ 2) Air flow from the outlet port to the inlet port