

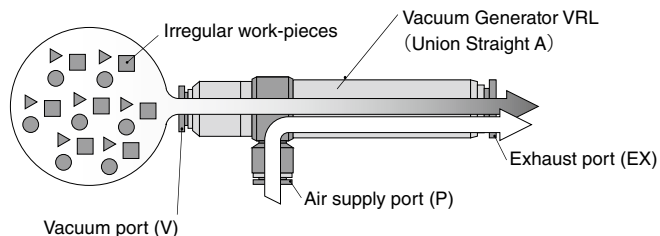

## Ejector for Conveying particles, powder and fibers Bore Through Vacuum Generator **VRL**

- *To convey small, irregular materials, such as particles, powder and fibers in the air current.*
- *The vacuum port and the exhaust port are located in a straight line. The works sucked in from the vacuum port pass through the inside of the vacuum generator and go out of the exhaust port. Thus the vacuum generator enables conveyance of works through a tube.*



- *Select the proper type according to work-piece size and the amount.*



## Model Designation (Example)

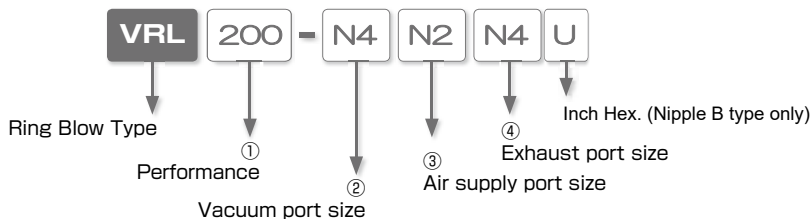

### ① Performance

Code	Suction flow ( $l/min(ANR)$ )	Final vacuum (-kPa)	Min. dia. of flow channel (mm)
50	50	53	$\phi 2.8$
100	100	53	$\phi 4.1$
200	200	53	$\phi 6$
300	300	53	$\phi 7.5$

※ The performance is based on the value at an air supply pressure 0.5MPa.

### ② Vacuum port size

Thread size	NPT thread (Nipple B type only)			
Code	N1	N2	N3	N4
Size	1/8NPT	1/4NPT	3/8NPT	1/2NPT

Joint type	Push-In Fitting					Taper pipe thread			
Code	06	08	10	12	16	01	02	03	04
Size	$\phi 6mm$	$\phi 8mm$	$\phi 10mm$	$\phi 12mm$	$\phi 16mm$	R1/8	R1/4	R3/8	R1/2

### ③ Air supply port size

Joint type	NPT thread (Nipple B type)		(Nipple A type)	Push-In Fitting			Taper pipe thread	
Code	N1	N2	※ 3/8	06	08	10	01	02
Size	1/8NPT	1/4NPT	3/8"	$\phi 6mm$	$\phi 8mm$	$\phi 10mm$	R1/8	R1/4

※ The available Nipple A type model is VRL100-N2 3/8 N2 only in this case. Ask us availability for other combination/type.

### ④ Exhaust port size

Thread size	NPT thread (Nipple B type only)		
Code	N1	N2	N4
Size	1/8NPT	1/4NPT	1/2NPT

  

Joint type	Push-In Fitting			Taper pipe thread		
Code	08	10	12	01	02	04
Size	$\phi 8mm$	$\phi 10mm$	$\phi 12mm$	R1/8	R1/4	R1/2

## Specification

Fluid medium	Air / Inert gas
Operating pressure range	0~ 130psi (0~0.9MPa)
Rated supply pressure	72.5psi (0.5MPa)
Operating temp. range	32~ 140°F (0~60°C)(No freezing)

## Construction (Union Straight A)

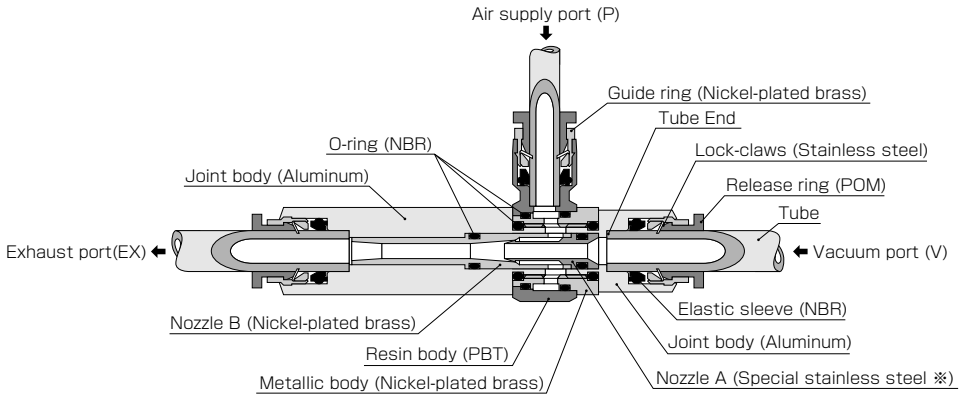

※ 2. Corrosion resistance is equivalent to SUS303.

## Characteristics

### Supply pressure - Final vacuum / Suction Flow / Air Consumption

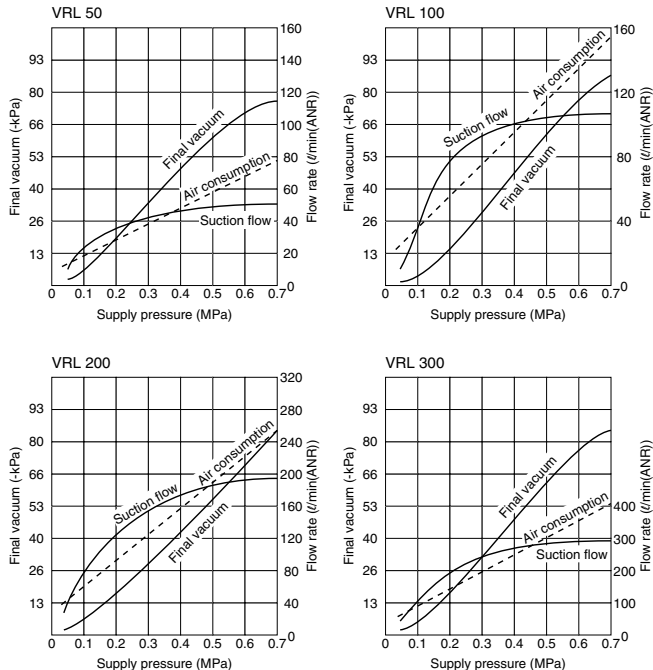

※ The above data is a measured value, not a guaranteed value. Measurement condition is with no pipe resistance. When there is any resistance on exhaust port side, the performance drops slightly.



## How to insert and disconnect

### 1. How to insert and disconnect tubes

#### ① Tube insertion

Insert a tube into Push-In Fitting of the vacuum generator VRL up to the tube end. Lock-claws bite the tube to fix it and the elastic sleeve seals around the tube.

Refer to "2. Instructions for Tube Insertion" under "Common Safety Instructions for Fittings" .

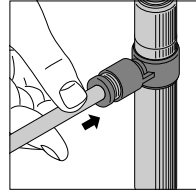

#### ② Tube disconnection

The tube is disconnected by pushing release-ring to release Lock-claws. Make sure to stop air supply before the tube disconnection.

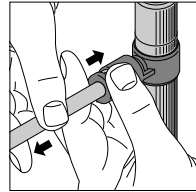

### 2. How to fix the product

Tighten a hexagonal-column by a proper spanner to fix vacuum generator VRL. Refer to the outer dimensional drawing in the catalog for hex size and recommended tightening torque.

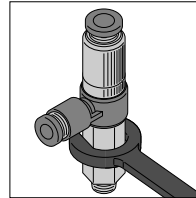

## ⚠ Detailed Safety Instructions

Before using PISCO products, be sure to read "Safety Instructions" and "Safety Instruction Manual" and "Common Safety Instructions for Vacuum Series".

### Warning

1. In some conditions, particles, powder and fibers may not be conveyed by Vacuum Generator VRL. Contact us for further information.
2. Use tube with inner diameter over  $\varnothing 12\text{mm}$  for the exhaust port of Push-in fitting with diameter  $\varnothing 16\text{mm}$ .

# Standard Size List

## Nipple type

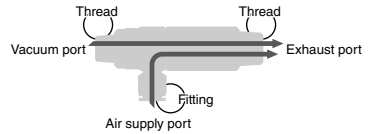
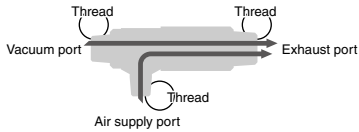

Type	Air supply port	Vacuum port				Exhaust port
		1/8NPT	1/4NPT	3/8NPT	1/2NPT	
<b>VRL</b> Nipple type B	1/8NPT	●				1/8NPT
NPT thread	1/4NPT		●		●	1/4NPT
				●	●	1/2NPT

Type	Air supply port	Vacuum port				Exhaust port
		R1/8	R1/4	R3/8	R1/2	
<b>VRL</b> Nipple type A	6mm	●				R1/8
	8mm	●				R1/4
	10mm		●	●	●	R1/2

Type	Air supply port	Vacuum port				Exhaust port
		R1/8	R1/4	R3/8	R1/2	
<b>VRL</b> Nipple type B	R1/8	●				R1/8
	R1/4		●			R1/4
				●	●	R1/2

## Straight

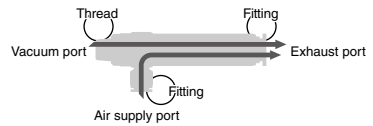
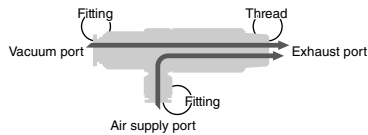

Type	Air supply port	Vacuum port					Exhaust port
		6mm	8mm	10mm	12mm	16mm	
<b>VRL</b> Straight A	6mm	●	●				R1/8
	8mm	●	●				R1/4
	10mm			●	●		R1/2

Type	Air supply port	Vacuum port				Exhaust port
		R1/8	R1/4	R3/8	R1/2	
<b>VRL</b> Straight B	6mm	●				8mm
	8mm	●				12mm
	10mm		●		●	16mm

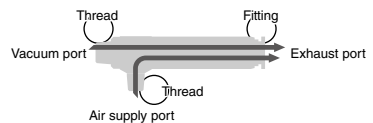
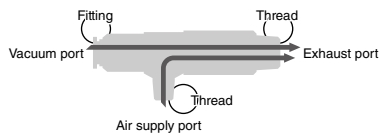

Type	Air supply port	Vacuum port					Exhaust port
		6mm	8mm	10mm	12mm	16mm	
<b>VRL</b> Straight C	R1/8	●	●				R1/8
	R1/4			●	●		R1/4
					●	●	R1/2

Type	Air supply port	Vacuum port				Exhaust port
		R1/8	R1/4	R3/8	R1/2	
<b>VRL</b> Straight D	R1/8	●				8mm
	R1/4		●			12mm
				●	●	16mm

## Union Straight

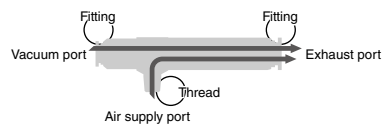
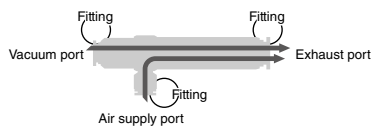

Type	Air supply port	Vacuum port					Exhaust port
		6mm	8mm	10mm	12mm	16mm	
<b>VRL</b> Union Straight A	6mm	●	●				8mm
	8mm		●				12mm
	10mm			●	●		16mm

Type	Air supply port	Vacuum port					Exhaust port
		6mm	8mm	10mm	12mm	16mm	
<b>VRL</b> Union Straight B	R1/8	●	●				8mm
	R1/4			●	●		12mm
					●	●	16mm



## VRL Nipple type B

RoHS compliant

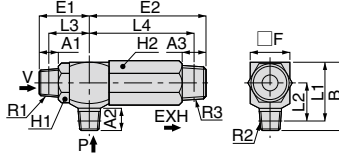

Unit : mm

Model code	R1	R2	R3	A1	A2	A3	B	L1	L2	L3	L4	E1	E2	Hex. H1	Hex. H2	F	Min. dia. of flow channel (ømm)	Final vacuum (-kPa)	Suction flow (l/min/ANR)	Air consumption (l/min/ANR)	Weight (g)	CAD file name
VRL50-N1N1N1	1/8NPT	1/8NPT	1/8NPT	8	8	8	28	23.9	15.9	16.9	33.9	21	38	14	14	16	2.8	53	50	50	38	
VRL100-N2N2N2	1/4NPT	1/4NPT	1/4NPT	11	11	11	35	29.2	19.2	21.2	49.2	27	55	17	17	20	4.1	53	100	100	80	
VRL200-N3N2N4	3/8NPT	1/4NPT	1/2NPT	12	11	15	42.5	36.7	24.2	25.4	64.9	31.5	73	22	22	25	6	53	200	200	171	—
VRL200-N4N2N4	1/2NPT	1/2NPT	1/2NPT	15						26.4	34.5									180		
VRL300-N3N2N4	3/8NPT	1/4NPT	1/2NPT	12	11	15	42.5	36.7	24.2	25.4	64.9	31.5	73	22	22	25	7.5	53	300	300	160	—
VRL300-N4N2N4	1/2NPT	1/2NPT	1/2NPT	15						26.4	34.5									169		
VRL50-010101	R1/8	R1/8	R1/8	8	8	8	28	24	16	17	34	21	38	14	14	16	2.8	53	50	50	37	—
VRL100-020202	R1/4	R1/4	R1/4	11	11	11	35	29	19	21	49	27	55	17	17	20	4.1	53	100	100	79	
VRL200-030204	R3/8	R1/4	R1/2	12	11	15	42.5	36.5	24	25.2	64.8	31.5	73	22	24	25	6	53	200	200	180	—
VRL200-040204	R1/2	R1/2	R1/2	15						26.3	34.5									194		
VRL300-030204	R3/8	R1/4	R1/2	12	11	15	42.5	36.5	24	25.2	64.8	31.5	73	22	24	25	7.5	53	300	300	170	—
VRL300-040204	R1/2	R1/2	R1/2	15						26.3	34.5									184		

※ "L1", "L2", "L3" and "L4" are referential dimensions after tightening thread.

## VRL Nipple type A

RoHS compliant

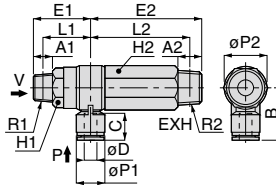

Unit : mm

Model code	Tube O.D. øD	R1	R2	A1	A2	B	E1	E2	L1	L2	øP1	øP2	C	Hex. H1	Hex. H2	Min. dia. of flow channel (ømm)	Final vacuum (-kPa)	Suction flow (l/min/ANR)	Air consumption (l/min/ANR)	Weight (g)	CAD file name	
VRL50-010601	6	R1/8	R1/8	8	8	25.5	23.4	35.6	19.4	31.6	12.4	—	17	14	14	2.8	53	50	50	41	Refer to page below	
VRL50-010801	8					28.4	24.4	34.6	20.4	30.6	14.4	—	18.1	17	17	4.1	53	100	100	81		
VRL100-020802	8	R1/4	R1/4	11	11	28.9	29	53	23	47	14.4	—	22	17	17	4.1	53	100	100	84		
VRL100-021002	10					31.2	30.3	51.7	24.3	45.7	17.6	—	20.2	17	17	4.1	53	100	100	84		
VRL200-031004	10	R3/8	R1/2	12	15	33.6	35.1	69.4	28.8	61.2	17.6	—	28	22	24	6	53	200	200	190		
VRL200-041004	10	R1/2	R1/2	15	15	33.6	38.1	69.4	29.9	61.2	17.6	—	28	24	24	6	53	200	200	204		
VRL300-031004	10	R3/8	R1/2	12	15	33.6	35.1	69.4	28.8	61.2	17.6	—	28	22	16	7.5	53	300	300	179		
VRL300-041004	10	R1/2	R1/2	15	15	33.6	38.1	69.4	29.9	61.2	17.6	—	28	24	16	7.5	53	300	300	193		
VRL100-N2 3/8 N2U	3/8	1/4NPT	1/4NPT	—	—	—	—	—	—	—	—	—	—	—	—	4.1	53	100	100	84		—

※ "L1" and "L2" are reference dimensions after tightening thread.

※ The NPT models highlighted in blue are available as special-made items from our stock.

# VRL Straight A

RoHS compliant

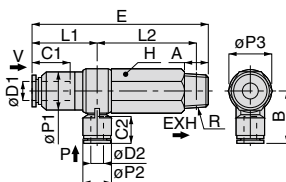

Unit : mm

Model code	Tube O.D. øD1	Tube O.D. øD2	R	A	B	E	L1	L2	øP1	øP2	øP3	C1	C2	対辺 H	Min. dia of flow channel (ømm)	Final vacuum (-kPa)	Suction flow (l/min) (AIR)	Air consumption (min) (AIR)	Weight (g)	CAD file name
VRL50-060601	6	6	R1/8	8	25.5	65.6	30	31.6	12.4	16	18.4	17	17	14	2.8	53	50	50	38	Refer to page bottom
VRL50-080601	8											18.2	18.2							
VRL50-060801	6	8	R1/8	8	28.4	65.6	31	30.6	14.4	20	22	17	18.1	17	4.1	53	100	100	40	
VRL50-080801	8											18.2	18.1							
VRL100-100802	10	8	R1/4	11	28.9	87.8	34.8	47	14.4	20	22	20.7	18.1	17	4.1	53	100	100	77	
VRL100-120802	12											23.3	20.2							
VRL100-101002	10	10	R1/4	11	31.2	87.8	36.1	45.7	17.6	20	22	20.7	20.2	17	4.1	53	100	100	80	
VRL100-121002	12											23.3	20.2							
VRL200-121004	12	10	R1/2	15	33.6	112.9	43.5	61.2	26	17.6	28	23.3	20.2	24	6	53	200	200	182	
VRL200-161004	16											24.8	20.2							
VRL300-121004	12	10	R1/2	15	33.6	112.9	43.5	61.2	26	17.6	28	23.3	20.2	24	7.5	53	300	300	172	
VRL300-161004	16											24.8	20.2							

※ "L2" is reference dimensions after tightening thread.

# VRL Straight B

RoHS compliant

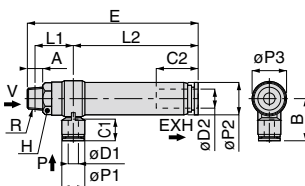

Unit : mm

Model code	Tube O.D. øD1	Tube O.D. øD2	R	A	B	E	L1	L2	øP1	øP2	øP3	C1	C2	対辺 H	Min. dia of flow channel (ømm)	Final vacuum (-kPa)	Suction flow (l/min) (AIR)	Air consumption (min) (AIR)	Weight (g)	CAD file name
VRL50-010608	6	8	R1/8	8	25.5	77.9	19.4	54.5	12.4	16	18.4	17	18.2	14	2.8	53	50	50	52	Refer to page bottom
VRL50-010808	8											18.1	18.2							
VRL100-020812	8	12	R1/4	11	28.9	105.4	23	76.4	14.4	20	22	18.1	23.3	17	4.1	53	100	100	108	
VRL100-021012	10											20.2	23.3							
VRL200-031016	10	16	R3/8	12	33.6	109.3	28.8	74.2	17.6	25	28	20.2	24.8	22	6	53	200	200	194	
VRL200-041016			R1/2	15										112.3						
VRL300-031016	10	16	R3/8	12	33.6	109.3	28.8	74.2	17.6	25	28	20.2	24.8	22	7.5	53	300	300	184	
VRL300-041016			R1/2	15										112.3						

※ "L1" is reference dimension after tightening thread.

## CAD file list

### Nipple type A

Model code	CAD file name	Model code	CAD file name
VRL50-010601	VRL50-010601	VRL50-010101	VRL50-010101
VRL50-010801	VRL50-010801	VRL100-020202	VRL100-020202
VRL100-020802	VRL100-020802	VRL200-030204	VRL200-030204
VRL100-021002	VRL100-021002	VRL200-040204	VRL200-040204
VRL200-031004	VRL200-031004	VRL300-030204	VRL300-030204
VRL200-041004	VRL200-041004	VRL300-040204	VRL300-040204
VRL300-031004	VRL300-031004		
VRL300-041004	VRL300-041004		

### Nipple type B

Model code	CAD file name	Model code	CAD file name
VRL50-010601	VRL50-010601	VRL50-010608	VRL50-010608
VRL50-080601	VRL50-080601	VRL50-010808	VRL50-010808
VRL50-060801	VRL50-060801	VRL100-020812	VRL100-020812
VRL50-080801	VRL50-080801	VRL100-021012	VRL100-021012
VRL100-100802	VRL100-100802	VRL200-031016	VRL200-031016
VRL100-120802	VRL100-120802	VRL200-041016	VRL200-041016
VRL100-101002	VRL100-101002	VRL300-031016	VRL300-031016
VRL100-121002	VRL100-121002	VRL300-041016	VRL300-041016
VRL200-121004	VRL200-121004		
VRL200-161004	VRL200-161004		
VRL300-121004	VRL300-121004		
VRL300-161004	VRL300-161004		

### Straight A

Model code	CAD file name	Model code	CAD file name
VRL50-060601	VRL50-060601	VRL50-010608	VRL50-010608
VRL50-080601	VRL50-080601	VRL50-010808	VRL50-010808
VRL50-060801	VRL50-060801	VRL100-020812	VRL100-020812
VRL50-080801	VRL50-080801	VRL100-021012	VRL100-021012
VRL100-100802	VRL100-100802	VRL200-031016	VRL200-031016
VRL100-120802	VRL100-120802	VRL200-041016	VRL200-041016
VRL100-101002	VRL100-101002	VRL300-031016	VRL300-031016
VRL100-121002	VRL100-121002	VRL300-041016	VRL300-041016
VRL200-121004	VRL200-121004		
VRL200-161004	VRL200-161004		
VRL300-121004	VRL300-121004		
VRL300-161004	VRL300-161004		

### Straight B

Model code	CAD file name	Model code	CAD file name
VRL50-010608	VRL50-010608	VRL50-010608	VRL50-010608
VRL50-010808	VRL50-010808	VRL50-010808	VRL50-010808
VRL100-020812	VRL100-020812	VRL100-020812	VRL100-020812
VRL100-021012	VRL100-021012	VRL100-021012	VRL100-021012
VRL200-031016	VRL200-031016	VRL200-031016	VRL200-031016
VRL200-041016	VRL200-041016	VRL200-041016	VRL200-041016
VRL300-031016	VRL300-031016	VRL300-031016	VRL300-031016
VRL300-041016	VRL300-041016	VRL300-041016	VRL300-041016



## VRL Straight C

RoHS compliant

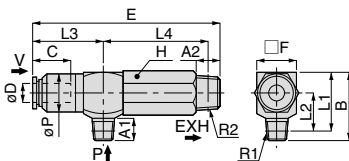

Unit : mm

Model code	Tube O.D. $\phi D$	R1	R2	A1	A2	B	L1	L2	L3	L4	E	$\phi P$	C	Hex. H1	$\square$ F	Min. dia. of flow orifice ( $\phi$ mm)	Final vacuum (-kPa)	Suction flow ( $\text{mm}^3/\text{AIR}$ )	Air consumption ( $\text{mm}^3/\text{AIR}$ )	Weight (g)	CAD file name
VRL50-060101	6						24	16	27.6		65.6	16	17	14	16	2.8	53	50	50	34	Refer to page bottom
VRL50-080101	8	R1/8	R1/8	8	8	28	20	16	27.9	34	65.9	16	18.2	14	16	2.8	53	50	50	34	
VRL100-100202	10								32.8		87.8		20.7							75	
VRL100-120202	12	R1/4	R1/4	11	11	35	25	19	35.4	49	90.4	20	23.3	17	20	4.1	53	100	100	76	
VRL200-120204	12								39.9	64.8	112.9	25	23.3	24	25	6	53	200	200	172	
VRL200-160204	16	R1/4	R1/2	11	15	42.5	30	24	41.3		114.3	25	24.8	24	25	6	53	200	200	174	
VRL300-120204	12								39.9		112.9		23.3							162	
VRL300-160204	16	R1/4	R1/2	11	15	42.5	30	24	41.3	64.8	114.3	25	24.8	24	25	7.5	53	300	300	163	

※ "L1", "L2" and "L4" are reference dimensions after tightening thread.

## VRL Straight D

RoHS compliant

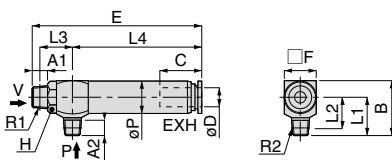

Unit : mm

Model code	Tube O.D. $\phi D$	R1	R2	A1	A2	B	L1	L2	L3	L4	E	C	$\phi P$	对边 H1	$\square$ F	Min. dia. of flow orifice ( $\phi$ mm)	Final vacuum (-kPa)	Suction flow ( $\text{mm}^3/\text{AIR}$ )	Air consumption ( $\text{mm}^3/\text{AIR}$ )	Weight (g)	CAD file name
VRL50-010108	8	R1/8	R1/8	8	8	28	20	16	17	56.9	77.9	18.2	16	14	16	2.8	53	50	50	49	Refer to page bottom
VRL100-020212	12	R1/4	R1/4	11	11	35	25	19	21	78.4	105.4	23.3	20	17	20	4.1	53	100	100	103	
VRL200-030216	16	R3/8	R1/4	12	11	42.5	30	24	25.2	77.8	109.3	24.8	25	22	25	6	53	200	200	185	
VRL200-040216		R1/2		15					26.3		112.3			24						199	
VRL300-030216	16	R3/8	R1/4	12	11	42.5	30	24	25.2	77.8	109.3	24.8	25	22	25	7.5	53	300	300	174	
VRL300-040216		R1/2		15					26.3		112.3			24						188	

※ "L2" and "L3" are reference dimension after tightening thread.

### ■ CAD file list

#### Straight C

#### Straight D

Model code	CAD file name	Model code	CAD file name
VRL50-060101	VRL50-060101	VRL50-010108	VRL50-010108
VRL50-080101	VRL50-080101	VRL100-020212	VRL100-020212
VRL100-100202	VRL100-100202	VRL200-030216	VRL200-030216
VRL100-120202	VRL100-120202	VRL200-040216	VRL200-040216
VRL200-120204	VRL200-120204	VRL300-030216	VRL300-030216
VRL200-160204	VRL200-160204	VRL300-040216	VRL300-040216
VRL300-120204	VRL300-120204		
VRL300-160204	VRL300-160204		



## VRL Union Straight A

RoHS compliant

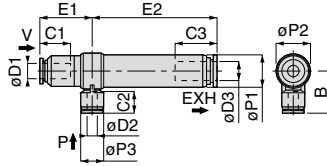

Unit : mm

Model code	Tube O.D. øD1	Tube O.D. øD2	Tube O.D. øD3	B	øP1	øP2	øP3	C1	C2	C3	E1	E2	Min. dia of flow channel (ømm)	Final vacuum (-kPa)	Suction flow (l/min(AIR))	Air consumption (l/min(AIR))	Weight (g)	CAD file name
VRL50-060608	6	6	8	25.5	16	18.4	12.4	17	17	18.2	30	54.5	2.8	53	50	50	49	Refer to page bottom
VRL50-060808		8																
VRL50-080608	8	6	8	25.5	16	18.4	12.4	17	18.2	18.2	30.3	54.5	2.8	53	50	50	49	
VRL50-080808		8																
VRL100-100812	10	8	12	28.9	20	22	14.4	20.7	18.1	23.3	34.8	76.4	4.1	53	100	100	102	
VRL100-120812	12																	
VRL100-101012	10	10	12	31.2	20	22	17.6	20.7	20.2	23.3	36.1	75.1	4.1	53	100	100	105	
VRL100-121012	12																	
VRL200-121016	12	10	16	33.6	25	28	17.6	23.3	20.2	24.8	43.5	74.2	6	53	200	200	186	
VRL200-161016	16																	
VRL300-121016	12	10	16	33.6	25	28	17.6	23.3	20.2	24.8	43.5	74.2	7.5	53	300	300	176	
VRL300-161016	16																	

## VRL Union Straight B

RoHS compliant

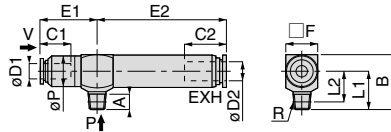

Unit : mm

Model code	Tube O.D. øD1	Tube O.D. øD2	R	A	B	L1	L2	øP	C1	C2	E1	E2	F	Min. dia of flow channel (ømm)	Final vacuum (-kPa)	Suction flow (l/min(AIR))	Air consumption (l/min(AIR))	Weight (g)	CAD file name
VRL50-060108	6	8	R1/8	8	28	23.4	35.6	16	17	18.2	27.6	56.9	16	2.8	53	50	50	45	Refer to page bottom
VRL50-080108	8					24.4	34.6		18.2		27.9								
VRL100-100212	10	12	R1/4	11	35	29	53	20	20.7	23.3	32.8	78.4	20	4.1	53	100	100	99	
VRL100-120212	12					30.3	51.7		23.3		35.4								
VRL200-120216	12	16	R1/4	11	42.5	35.1	69.4	25	23.3	24.8	39.9	77.8	25	6	53	200	200	177	
VRL200-160216	16					38.1	69.4		24.8		41.3								
VRL300-120216	12	16	R1/4	11	42.5	35.1	69.4	25	23.3	24.8	39.9	77.8	25	7.5	53	300	300	166	
VRL300-160216	16					38.1	69.4		24.8		41.3								

※ "L2" is reference dimension after tightening thread.

## CAD file list

Union Straight A

Union Straight B

Model code	CAD file name	Model code	CAD file name	Model code	CAD file name
VRL50-060608	VRL50-060608	VRL200-121016	VRL200-121016	VRL50-060108	VRL50-060108
VRL50-060808	VRL50-060808	VRL200-161016	VRL200-161016	VRL50-080108	VRL50-080108
VRL50-080608	VRL50-080608	VRL300-121016	VRL300-121016	VRL100-100212	VRL100-100212
VRL50-080808	VRL50-080808	VRL300-161016	VRL300-161016	VRL100-120212	VRL100-120212
VRL100-100812	VRL100-100812			VRL200-120216	VRL200-120216
VRL100-120812	VRL100-120812			VRL200-160216	VRL200-160216
VRL100-101012	VRL100-101012			VRL300-120216	VRL300-120216
VRL100-121012	VRL100-121012			VRL300-160216	VRL300-160216



# SAFETY Instructions

This safety instructions aim to prevent personal injury and damage to properties by requiring proper use of PISCO products.

Be certain to follow ISO 4414 and JIS B 8370

ISO 4414 : Pneumatic fluid power...Recommendations for the application of equipment to transmission and control systems.

JIS B 8370 : General rules and safety requirements for systems and their components.

This safety instructions is classified into "Danger", "Warning" and "Caution" depending on the degree of danger or damages caused by improper use of PISCO products.



**Danger**

Hazardous conditions. It can cause death or serious personal injury.



**Warning**

Hazardous conditions depending on usages. Improper use of PISCO products can cause death or serious personal injury.



**Caution**

Hazardous conditions depending on usages. Improper use of PISCO products can cause personal injury or damages to properties.



## Warning

### 1. Selection of pneumatic products

- ① A user who is a pneumatic system designer or has sufficient experience and technical expertise should select PISCO products.
- ② Due to wide variety of operating conditions and applications for PISCO products, carry out the analysis and evaluation on PISCO products. The pneumatic system designer is solely responsible for assuring that the user's requirements are met and that the application presents no health or safety hazards. All designers are required to fully understand the specifications of PISCO products and constitute all systems based on the latest catalog or information, considering any malfunctions.

### 2. Handle the pneumatic equipment with enough knowledge and experience

- ① Improper use of compressed air is dangerous. Assembly, operation and maintenance of machines using pneumatic equipment should be conducted by a person with enough knowledge and experience.

### 3. Do not operate machine / equipment or remove pneumatic equipment until safety is confirmed.

- ① Make sure that preventive measures against falling work-pieces or sudden movements of machine are completed before inspection or maintenance of these machine.
- ② Make sure the above preventive measures are completed. A compressed air supply and the power supply to the machine must be off, and also the compressed air in the systems must be exhausted.
- ③ Restart the machines with care after ensuring to take all preventive measures against sudden movements.

## Disclaimer

1. PISCO does not take any responsibility for any incidental or indirect loss, such as production line stop, interruption of business, loss of benefits, personal injury, etc., caused by any failure on use or application of PISCO products.
2. PISCO does not take any responsibility for any loss caused by natural disasters, fires not related to PISCO products, acts by third parties, and intentional or accidental damages of PISCO products due to incorrect usage.
3. PISCO does not take any responsibility for any loss caused by improper usage of PISCO products such as exceeding the specification limit or not following the usage the published instructions and catalog allow.
4. PISCO does not take any responsibility for any loss caused by remodeling of PISCO products, or by combinational use with non-PISCO products and other software systems.
5. The damages caused by the defect of Pisco products shall be covered but limited to the full amount of the PISCO products paid by the customer.



# SAFETY INSTRUCTION MANUAL

PISCO products are designed and manufactured for use in general industrial machines. Be sure to read and follow the instructions below.

## Danger

1. Do not use PISCO products for the following applications.
  - ① Equipment used for maintaining / handling human life and body.
  - ② Equipment used for moving / transporting human.
  - ③ Equipment specifically used for safety purposes.

## Warning

1. Do not use PISCO products under the following conditions.
  - ① Beyond the specifications or conditions stated in the catalog, or the instructions.
  - ② Under the direct sunlight or outdoors.
  - ③ Excessive vibrations and impacts.
  - ④ Exposure / adhere to corrosive gas, inflammable gas, chemicals, seawater, water and vapor. \*  
\* Some products can be used under the condition above(④), refer to the details of specification and condition of each product.
2. Do not disassemble or modify PISCO products, which affect the performance, function, and basic structure of the product.
3. Turn off the power supply, stop the air supply to PISCO products, and make sure there is no residual air pressure in the pipes before maintenance and inspection.
4. Do not touch the release-ring of push-in fitting when there is a working pressure. The lock may be released by the physical contact, and tube may fly out or slip out.
5. Frequent switchover of compressed air may generate heat, and there is a risk of causing burn injury.
6. Avoid any load on PISCO products, such as a tensile strength, twisting and bending. Otherwise, there is a risk of causing damage to the products.
7. As for applications where threads or tubes swing / rotate, use Rotary Joints, High Rotary Joints or Multi-Circuit Rotary Block only. The other PISCO products can be damaged in these applications.
8. Use only Die Temperature Control Fitting Series, Tube Fitting Stainless SUS316 Series, Tube Fitting Stainless SUS316 Compression Fitting Series or Tube Fitting Brass Series under the condition of over 60°C (140° F) water or thermal oil. Other PISCO products can be damaged by heat and hydrolysis under the condition above.
9. As for the condition required to dissipate static electricity or provide an antistatic performance, use EG series fitting and antistatic products only, and do not use other PISCO products. There is a risk that static electricity can cause system defects or failures.
10. Use only Fittings with a characteristic of spatter-proof such as Anti-spatter or Brass series in a place where flame and weld spatter is produced. There is a risk of causing fire by sparks.
11. Turn off the power supply to PISCO products, and make sure there is no residual air pressure in the pipes and equipment before maintenance. Follow the instructions below in order to ensure safety.
  - ① Make sure the safety of all systems related to PISCO products before maintenance.
  - ② Restart of operation after maintenance shall be proceeded with care after ensuring safety of the system by preventive measures against unexpected movements of machines and devices where pneumatic equipment is used.
  - ③ Keep enough space for maintenance when designing a circuit.
12. Take safety measures such as providing a protection cover if there is a risk of causing damages or fires on machine / facilities by a fluid leakage.

## ⚠ Caution

1. Remove dusts or drain before piping. They may get into the peripheral machine / facilities and cause malfunction.
2. When inserting an ultra-soft tube into push-in fitting, make sure to place an Insert Ring into the tube edge. There is a risk of causing the escape of tube and a fluid leakage without using an Insert Ring.
3. The product incorporating NBR as seal rubber material has a risk of malfunction caused by ozone crack. Ozone exists in high concentrations in static elimination air, clean-room, and near the high-voltage motors, etc. As a countermeasure, material change from NBR to HNBR or FKM is necessary. Consult with PISCO for more information.
4. Special option "Oil-free" products may cause a very small amount of a fluid leakage. When a fluid medium is liquid or the products are required to be used in harsh environments, contact us for further information.
5. In case of using non-PISCO brand tubes, make sure the tolerance of the outer tube diameter is within the limits of Table 1.

● Table 1. Tube O.D. Tolerance

mm size	Nylon tube	Polyurethane tube	inch size	Nylon tube	Polyurethane tube
ø1.8mm	—	± 0.05mm	ø1/8	± 0.1mm	± 0.15mm
ø3mm	—	± 0.15mm	ø5/32	± 0.1mm	± 0.15mm
ø4mm	± 0.1mm	± 0.15mm	ø3/16	± 0.1mm	± 0.15mm
ø6mm	± 0.1mm	± 0.15mm	ø1/4	± 0.1mm	± 0.15mm
ø8mm	± 0.1mm	± 0.15mm	ø5/16	± 0.1mm	± 0.15mm
ø10mm	± 0.1mm	± 0.15mm	ø3/8	± 0.1mm	± 0.15mm
ø12mm	± 0.1mm	± 0.15mm	ø1/2	± 0.1mm	± 0.15mm
ø16mm	± 0.1mm	± 0.15mm	ø5/8	± 0.1mm	± 0.15mm

## 6. Instructions for Tube Insertion

- ① Make sure that the cut end surface of the tube is at right angle without a scratch on the surface and deformations.
- ② When inserting a tube, the tube needs to be inserted fully into the push-in fitting until the tubing edge touches the tube end of the fitting as shown in the figure below. Otherwise, there is a risk of leakage.

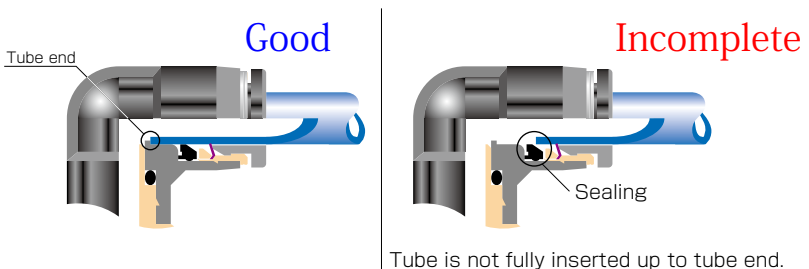

- ③ After inserting the tube, make sure it is inserted properly and not to be disconnected by pulling it moderately.
- ※ When inserting tubes, Lock-claws may be hardly visible in the hole, observed from the front face of the release-ring. But it does not mean the tube will surely escape. Major causes of the tube escape are the followings;
- ① Shear drop of the lock-claws edge
  - ② The problem of tube diameter (usually small)
- Therefore, follow the above instructions from ① to ③, even lock-claws is hardly visible.

7. Instructions for Tube Disconnection

- ① Make sure there is no air pressure inside of the tube, before disconnecting it.
- ② Push the release-ring of the push-in fitting evenly and deeply enough to pull out the tube toward oneself. By insufficient pushing of the release-ring, the tube may not be pulled out or damaged by scratch, and tube shavings may remain inside of the fitting, which may cause the leakage later.

8. Instructions for Installing a fitting

- ① When installing a fitting, use proper tools to tighten a hexagonal-column or an inner hexagonal socket. When inserting a hex key into the inner hexagonal socket of the fitting, be careful so that the tool does not touch lock-claws. The deformation of lock-claws may result in a poor performance of systems or an escape of the tube.
- ② Refer to Table 2 which shows the recommended tightening torque. Do not exceed these limits to tighten a thread. Excessive tightening may break the thread part or deform the gasket and cause a fluid leakage. Tightening thread with tightening torque lower than these limits may cause a loosened thread or a fluid leakage.
- ③ Adjust the tube direction while tightening thread within these limits, since some PISCO products are not rotatable after the installation.

● Table 2: Recommended tightening torque / Sealock color / Gasket materials

Thread type	Thread size	Tightening torque	Sealock color	Gasket materials
Metric thread	M3 × 0.5	0.7N·m	—	SUS304 NBR
	M5 × 0.8	1.0 ~ 1.5N·m		
	M6 × 1	2 ~ 2.7N·m		
	M3 × 0.5	0.5 ~ 0.6N·m		POM
	M5 × 0.8	1 ~ 1.5N·m		
	M6 × 0.75	0.8 ~ 1N·m		
Taper pipe thread	M8 × 0.75	1 ~ 2N·m	White	—
	R1/8	7 ~ 9N·m		
	R1/4	12 ~ 14N·m		
	R3/8	22 ~ 24N·m		
Unified thread	R1/2	28 ~ 30N·m	—	SUS304, NBR
	No.10-32UNF	1.0 ~ 1.5N·m		
National pipe thread taper	1/16-27NPT	7 ~ 9N·m	White	—
	1/8-27NPT	7 ~ 9N·m		
	1/4-18NPT	12 ~ 14N·m		
	3/8-18NPT	22 ~ 24N·m		
	1/2-14NPT	28 ~ 30N·m		

※ These values may differ for some products. Refer to each specification as well.

9. Instructions for removing a fitting

- ① When removing a fitting, use proper tools to loosen a hexagonal-column or an inner hex bolt.
- ② Remove the sealant stuck on the mating equipment. The remained sealant may get into the peripheral equipment and cause malfunctions.

10. Arrange piping avoiding any load on fittings and tubes such as twist, tensile, moment load, shaking and physical impact. These may cause damages to fittings, tube deformations, bursting and the escape of tubes.



## Common Safety Instructions for Vacuum Series

Before selecting or using PISCO products, read the following instructions. Read the detailed instructions for individual series.

### Warning

1. If there is a risk of dropping work-pieces during vacuum suction, take a safety measure against the falling of them.
2. Avoid supplying more than 0.1MPa pressure constantly in a vacuum circuit. Since vacuum generators are not explosive-proof, there is a risk of damaging the products.
3. Pay attention to drop of vacuum pressure caused by problems of the supplied air or the power supply. Decrease of suction force may lead to a danger of falling work-piece so that safety measure against the falling of them is necessary.
4. When more than 2 vacuum pads are plumbed on a single ejector and one of them has a suction problem such as vacuum leak, there is a risk of releasing work-pieces from the other pad due to the drop of the vacuum pressure.
5. Do not use in the way by which exhaust port is blocked or exhaust resistance is increased. Otherwise, there is a risk of no vacuum generation or a drop of the vacuum pressure.
6. Do not use the product in the circumstance of corrosive gas, inflammable gas, explosive gas, chemicals, seawater and vapor or do not expose the product to those. Never allow the product to suck those things.
7. Provide a protective cover on the products when it is exposed to sunlight.
8. Carry out clogging check for silencer element in an ejector and a vacuum filter periodically. Clogged element will be a cause to impair the performance or a cause of troubles.
9. Before replacing the element, thoroughly read and understand the method of filter replacement in the catalog.
10. Make sure the correct port of the vacuum generator by this catalog or marking on the products when plumbing. Wrong plumbing can be a risk to damage the product.
11. Supply clean air without sludge or dusts to an ejector. Do not lubricate by a lubricator. There is a risk of malfunction or performance impairing by impurities and oil contained in the compressed air.
12. Do not apply extreme tension, twist or bending forces on a lead wire. Otherwise, it may cause a wire breaking.
13. Locknut needs to be tightened firmly by hand. Do not use any tool to tighten. In case of using tools to tighten the locknut, it may damage the locknut or the product. Inadequate tightening may loosen the locknut and the initial setting can be changed.
14. Do not force the product to rotate or swing even its resin body is rotatable. It may cause damage to the product and a fluid leakage.
15. Do not supply an air pressure or a dry air to the products over the necessary amount. There is a risk of deteriorating rubber materials and malfunction due to oil.
16. Keep the product away from water, oil drops or dusts. These may cause malfunction. Take a proper measure to protect the product before the operation.

17. Do not use the product in the environment of inflammable or explosive gas / fluid. It can cause a fire or an explosion hazard.
18. Do not use the product in the circumstance of corrosive gas, inflammable gas, explosive gas, chemicals, seawater and vapor or do not expose the product to those. Otherwise, it may be a cause of malfunction.
19. Do not clean or paint the products by water or a solvent.

## **Caution**

1. Operating pressure range in the catalog is the values during ejector operation. Secure the described value of the supplied air, taking a drop of the pressure into consideration. Insufficient pressure, which does not satisfy the spec, may cause abnormal noise, unstable performance and may negatively affect sensors, bringing troubles at last.
2. Effective cross-section area of the air supply side needs to be three times as large as effective cross-section area of the nozzle bore. When arranging piping or selecting PISCO products, secure required effective cross-section area. Insufficient supply pressure may be a cause to impair performance.
3. A Shorter distance of plumbing with a wider bore is preferable at vacuum system side. A long plumbing with a small bore may result in slow response time at the time of releasing work-piece as well as in failure to secure adequate suction flow rate.
4. Plumb a vacuum switch and an ejector with vacuum switch at the end of vacuum system as much as possible. A long distance between a vacuum switch and a vacuum system end may increase plumbing resistance which may lead to a high vacuum level at the sensor even when no suctioning and a malfunction of vacuum switch. Make sure to evaluate the products in an actual system.
5. Refer to "4. Instructions for Installing a fitting" and "5. Instructions for Removing a fitting" under "Common Safety Instructions for Fittings" , when installing or removing Fittings.
6. Refer to "Common Safety Instructions for Pressure Sensors" and "Detailed Safety Instructions" for the handling of digital vacuum switch sensor.
7. Refer to "Common Safety Instructions for Mechanical Vacuum Sensor" for the handling of mechanical vacuum switch.
8. The material of plastic filter cover for VG, VK, VJ, VZ and VX series is PCTG. Avoid the adherence of Chemicals below to the products, and do not use them under those chemical environments.

### ● Table Chemical Name

Chemical Name
Thinner
Carbon tetrachloride
Chloroform
Acetate
Aniline
Cyclohexane
Trichloroethylene
Sulfuric acid
Lactic acid
Water soluble cutting oil (alkaline)

\* There are more chemicals which should be avoided. Contact us for the use under chemical circumstance.



## Vacuum Generator

9. The material of plastic filter cover for VQ and VFU series is PA. Avoid the adherence of chemicals below to the products, and do not use them under those chemical environments.

● Table Chemical Name

Chemical Name
Methanol
Ethanol
Nitric acid
Sulfuric acid
Hydrochloric acid
Lactic acid
Acetone
Chloroform
Aniline
Trichloroethylene
Hydrogen peroxide

\* There are more chemicals which should be avoided. Contact us for the use under chemical circumstance.