

PDF Compressor Free Version



Suitable for work-piece which is easy to be deformed and wrinkled

Vacuum Pad Flat Series

- Wide selection of pad sizes, materials and holder types.

Pad size : 5sizes. Pad material : 6types. Holder type : 11types.

- Groove on a flat pad reduces deformation and wrinkle on a work-piece.



A piece of sheet sucked with
Vacuum pad Ultrathin series

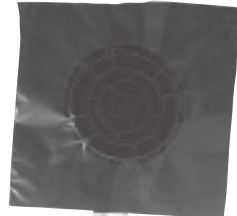

A piece of sheet sucked with
Vacuum pad Flat series

- Stroke length of a spring holder is selectable.

- Conventional long stroke holder (with cover) is integrated into VPC or VPD.
Stroke : 6, 10, 15 and 20 mm
- Conventional long stroke holder (without cover) is renewed as VPOC or VPOD.
Stroke : 20, 30, 40 and 50mm

- Variety of selections in pad holder for "Copper alloy free" and against "low ozone concentration".

-S3 spec. : No copper based metal parts. HNBR or FKM is adopted for seal rubber.



■ Selection list

Pad type **PDF Compressor Free Version**

Flat



Thin work-piece such as sheet or plastic bag

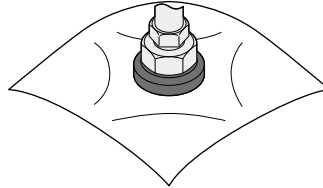

Recommended work-piece

Pad size

5 sizes

ø10, ø15, ø20, ø25, ø30mm

Pad material

6 types

Nitrile rubber, Silicone rubber, Urethane rubber, Fluoro rubber, Conductive NBR (Low resistance), Conductive silicone rubber,

Holder size

Mini

Standard

Holder type

4 types

7 types

Fixed type



Spring type

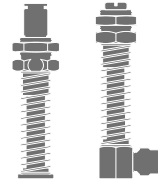

Holder without cover is available.

Direct mount
(Fixed type or Spring type)



■ Usage reference

■ Flat Compressor: Ex. 1. Thin workpieces

Use of a smaller diameter pad with low vacuum level is necessary to avoid adsorbing two or more workpieces at once. An air blow and retaining claws like the figure below are also useful.

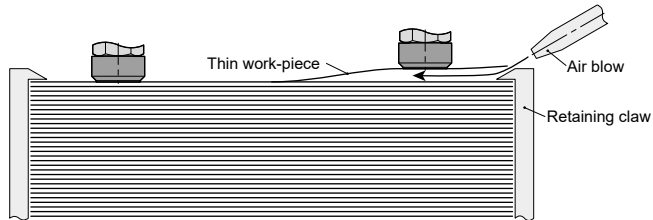

■ Model designation of Pad rubber only (Ex.)

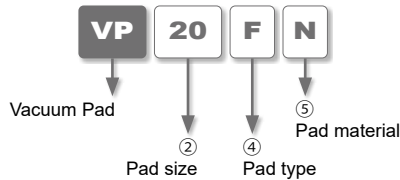

② .Pad size

Code	10	15	20	25	30
Size(mm)	ø10	ø15	ø20	ø25	ø30
Connection config. code	-M4			-M6	

④ .Pad type

Code	F
Type	Flat

⑤ .Pad material / Application

Code	N	S	U	F	NE	SE
Rubber material	Nitrile rubber	Silicone rubber	Urethane rubber	Fluoro rubber	Conductive NBR (Low resistance)	Conductive silicone
Application	Cardboard Plywood Iron plate Food-related Other general work-pieces	Semiconductors Taking out molded parts Thin workpieces Food-related	Cardboard Plywood Iron plate	Chemical environment High temp. work-pieces	Semiconductors	Semiconductors Taking out molded parts Thin work-pieces
Color	Black	Natural (Ivory)	Blue	Gray	Black	Black

※ 1.The material of Conductive NBR (low resistance) is a nitrile rubber (Volume resistance : 200Ω cm or less)

※ 2.Pad material N and NE are not suitable for use under ozone environment.

Model designation of Pad & screw set (Ex.)

PDF Compressor Free Version

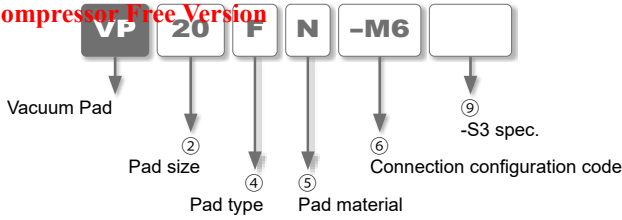

For ②, ④ and ⑤, refer to "Model designation of Pad rubber only (Ex.)" on page 912.

⑥. Connection configuration code

Code	-M4	-M6
Pad size (mm)	ø10, ø15	ø20~ø30

⑨. -S3 spec.

Code	No code	-S3
Spec.	Standard	Metal parts : Copper alloy free material Seal parts : FKM or HNBR

Vacuum Pad dimensions

VP10F Weight : 0.6g[0.9g]

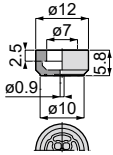

VP15F Weight : 1.1g[1.7g]

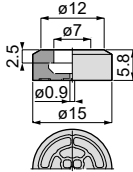

VP20F Weight : 1.4g[2.3g]

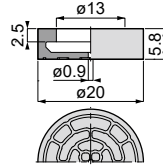

VP25F Weight : 2.6g[4.1g]

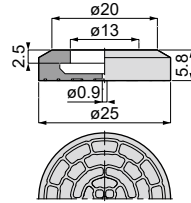

VP30F Weight : 3.5g[5.1g]

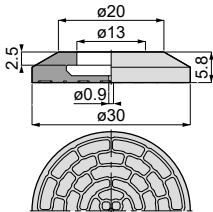

※ Weight in [] is the weight of Fluoro rubber.

■ Dimensions of Pad & screw set

VP10F^[5]-M4^[9] VP15F^[5]-M4^[9] VP20F^[5]-M6^[9] VP25F^[5]-M6^[9] VP30F^[5]-M6^[9]

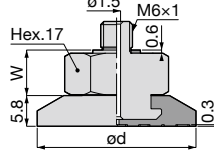
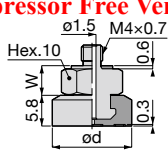

Unit : mm

Model code	Pad O.D. ød	W	Connection configuration code
VP10F ^[5] -M4 ^[9]	10	5.6	-M4
VP15F ^[5] -M4 ^[9]	15	5.6	
VP20F ^[5] -M6 ^[9]	20	8.6	-M6
VP25F ^[5] -M6 ^[9]	25	8.6	
VP30F ^[5] -M6 ^[9]	30	8.6	

※ [5] : Replaced with Pad rubber material code. Refer to page 916 for details.

※ [9] : Replaced with "-S3" for -S3 spec. (Copper alloy free material for metal parts and FKM or HNBR for sealing parts).

■ Pad screw dimensions

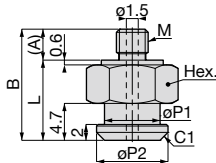

Unit : mm

Pad screw Model code	M	A	B	L	øP1	øP2	Hex. Hex.	Weight (g)	Applicable pad model code
FVPLF15-M4 ^[9]	M4×0.7	3.9	14	10.1	7	9	10	5	VP10, 15F ^[5]
FVPLF30-M6 ^[9]	M6×1	5.4	18.5	13.1	13	17	17	22	VP20~30F ^[5]

※ [9] : Replaced with "-S3" for -S3 spec. (Copper alloy free material for metal parts and FKM or HNBR for sealing parts).

■ Table of Connection configuration code, etc. for connection of pad and holder

Pad dia. (mm)	Model code of pad rubber	Connection type	Connection configuration code	Model code of Pad & screw set	Table of complement parts model code
					Pad screw
ø10	VP10F ^[5]	Screw type (Connection with screw)	-M4	VP10F ^[5] -M4 ^[9]	FVPLF15-M4 ^[9]
ø15	VP15F ^[5]			VP15F ^[5] -M4 ^[9]	
ø20	VP20F ^[5]			VP20F ^[5] -M6 ^[9]	FVPLF30-M6 ^[9]
ø25	VP25F ^[5]			VP25F ^[5] -M6 ^[9]	
ø30	VP30F ^[5]			VP30F ^[5] -M6 ^[9]	

Model designation of Holder + Pad (Ex.)

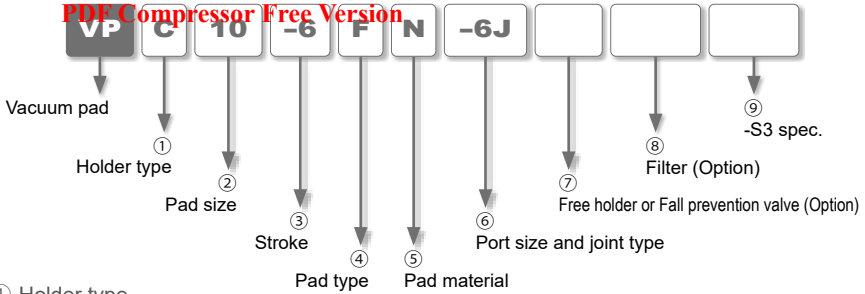

①. Holder type

Code	Mini	MA	Code	Mini	MB	Code	Mini	MC
	Standard	A		Standard	B		Standard	C
	No cover	-		No cover	-		No cover	OC
Type	Fixed type / Top port		Type	Fixed type / Side port		Type	Spring type / Top port	
Code	Mini	MD	Code	Mini	-	Code	Mini	-
	Standard	D		Standard	F		Standard	-
	No cover	OD		No cover	-		No cover	-
Type	Spring type / Side port		Type	Spring type / Direct mount		Type	Spring type / Direct mount	

②. Pad size

Code	10	15	20	25	30
Size (mm)	ø10	ø15	ø20	ø25	ø30
Connection config. code	-M4		-M6		

③. Stroke (No code entry for Holder code : MA, A, MB, B and F)

Code	-4	-6	-10	-15	-20	-30	-40	-50
Stroke (mm)	4	6	10	15	20	30	40	50
Pad holder code	VPMC	○(-M4, -M6)						
	VPC		○(-M4, -M6)	○(-M4, -M6)	○(-M4, -M6)	○(-M4, -M6)		
	VPOC					○(-M6)	○(-M6)	○(-M6)
	VPMD	○(-M4, -M6)						
	VPD		○(-M4, -M6)	○(-M4, -M6)	○(-M4, -M6)	○(-M4, -M6)		
	VPOD					○(-M6)	○(-M6)	○(-M6)

※. Code in () : Connection configuration code.

④. Pad type

Code	F
Type	Flat

PDF Compressor Free Version

⑤.Pad material / Application

Code	N	S	U	F	NE	SE
Rubber material	Nitrile rubber	Silicone rubber	Urethane rubber	Fluoro rubber	Conductive NBR (Low resistance)	Conductive silicone
Application	Cardboard Plywood Iron plate Food-related Other general work-pieces	Semiconductors Taking out molded parts Thin workpieces Food-related	Cardboard Plywood Iron plate	Chemical environment High temp. work-pieces	Semiconductors	Semiconductors Taking out molded parts Thin work-pieces
Color	Black	Natural (Ivory)	Blue	Gray	Black	Black

※ 1.The material of Conductive NBR (low resistance) is a nitrile rubber (Volume resistance : 200Ω·cm or less)

※ 2.Pad material N and NE are not suitable for use under ozone environment.

⑥.Port size and joint type

Joint type	Push-in fitting (mm)					Barb fitting (mm)			Female thread	
Code	-180J	-2J	-3J	-4J	-6J	-3B	-4B	-6B	-M5	-M6
Size	ø1.8	ø2	ø3	ø4	ø6	ø3×ø2	ø4×ø2.5	ø6×ø4	M5×0.8	M6×1
ø1.8	○	○	○	○	○	○	○	○	○	○
ø2	○	○	○	○	○	○	○	○	○	○
ø3	○	○	○	○	○	○	○	○	○	○
ø4	○	○	○	○	○	○	○	○	○	○
ø6	○	○	○	○	○	○	○	○	○	○

※.Joint size differs depending on the holder type. Check the joint size by the holder dimensions lists in following pages.

⑦.Free holder or Fall prevention valve (Option)

Code	FH	FHH	ECV
Option	Free holder articulation angle : 30°	Free holder articulation angle : 15°	Fall prevention valve

⑧.Filter (Option)

Code	F15	F30
Pad dia. (mm)	ø10 ~ ø30mm	ø20 ~ ø30mm

※ . Recommended pad size for F15 : ø10 ~ ø25mm

⑨.-S3 spec.

Code	No code	-S3
Spec.	Standard	Metal parts material : Copper alloy free material Sealing parts material : FKM or HNBR

※ . Free holder, Fall prevention valve and Filter are not available when "-S3" is selected.

Vacuum pad + Fixed type holder Dimensions

VPMA Fixed type / Top port / Push in fitting / Mini holder

RoHS Compliant Copper alloy free available CAD (2D&3D)

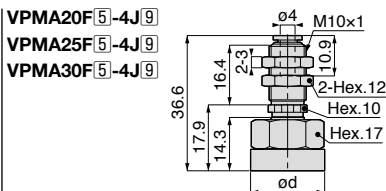
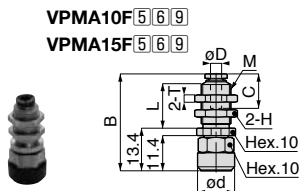

Unit : mm

Model code	Pad O.D. øD	Tube O.D. øD	Thread M	B	L	Tube end C	Hex. H	T	Connection config. code
VPMA10F[5][6][9]-3J	10	3	M8×0.75	28.2	12.5	9.4	10	2	-M4
VPMA10F[5][6][9]-4J[9]		4	M10×1	32.1	16.4	10.9	12	3	
VPMA15F[5][6][9]-3J	15	3	M8×0.75	28.2	12.5	9.4	10	2	
VPMA15F[5][6][9]-4J[9]		4	M10×1	32.1	16.4	10.9	12	3	
VPMA20F[5][6][9]-4J[9]	20	—	—	—	—	—	—	—	-M6
VPMA25F[5][6][9]-4J[9]	25	—	—	—	—	—	—	—	
VPMA30F[5][6][9]-4J[9]	30	—	—	—	—	—	—	—	

※ [5] : Replaced with Pad rubber material code. Refer to page 916 for details.

※ [9] : Replaced with "-S3" for -S3 spec. (Copper alloy free material for metal parts and FKM or HNBR for sealing parts). -S3 spec. is available for model codes with [9] in the table above.

※ Pad material N and NE are not suitable for use under ozone environment.

※ Tightening torque of a pad holder fixing bulkhead nut is as followings. Thread size : M8×0.75 ▶ 2.5~3.5N·m. Thread size : M10×1 ▶ 5~7N·m.

VPMA Fixed type / Top port / Barb fitting / Mini holder

RoHS Compliant Copper alloy free available CAD (2D&3D)

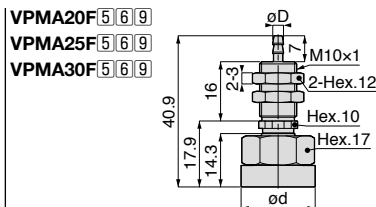
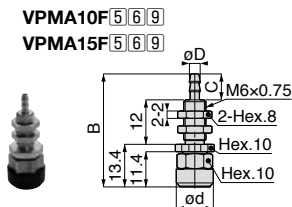

Unit : mm

Model code	Pad O.D. øD	Tube I.D. øD	B	C	Connection config. code
VPMA10F[5][6][9]-3B[9]	10	2	31.4	6	-M4
VPMA10F[5][6][9]-4B[9]		2.5	32.4	7	
VPMA15F[5][6][9]-3B[9]	15	2	31.4	6	
VPMA15F[5][6][9]-4B[9]		2.5	32.4	7	
VPMA20F[5][6][9]-4B[9]	20	2.5	—	—	-M6
VPMA20F[5][6][9]-6B[9]		4			
VPMA25F[5][6][9]-4B[9]	25	2.5	—	—	
VPMA25F[5][6][9]-6B[9]		4			
VPMA30F[5][6][9]-4B[9]	30	2.5	—	—	
VPMA30F[5][6][9]-6B[9]		4			

※ [5] : Replaced with Pad rubber material code. Refer to page 916 for details.

※ [9] : Replaced with "-S3" for -S3 spec. (Copper alloy free material for metal parts and FKM or HNBR for sealing parts).

※ Pad material N and NE are not suitable for use under ozone environment.

※ Tightening torque of a pad holder fixing bulkhead nut is as followings. Thread size : M6×0.75 ▶ 2~3N·m. Thread size : M10×1 ▶ 5~7N·m.

VPA Fixed type / Top port / Push-in fitting / Standard holder

RoHS Compliant Copper alloy free available CAD (2D&3D)



VPA10F^[5][6]^[9]

VPA15F^[5][6]^[9]

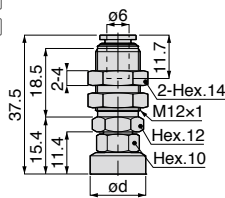

VPA20F^[5][6]^[9]

VPA25F^[5][6]^[9]

VPA30F^[5][6]^[9]

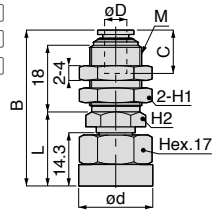

Unit : mm

Model code	Pad O.D. ød	Tube O.D. øD	Thread M	B	L	Tube end C	Hex. H1	Hex. H2	Connection config. code
VPA10F ^[5] -6J ^[9]	10	—	—	—	—	—	—	—	-M4
VPA15F ^[5] -6J ^[9]	15	—	—	—	—	—	—	—	
VPA20F ^[5] -3J	20	3	M12×1	51	20.3	10.9	14	12	-M6
VPA20F ^[5] -4J ^[9]		4							
VPA20F ^[5] -6J ^[9]		6	M14×1	42	19.9	11.7	17	14	
VPA25F ^[5] -3J	25	3	M12×1	51	20.3	10.9	14	12	
VPA25F ^[5] -4J ^[9]		4							
VPA25F ^[5] -6J ^[9]		6	M14×1	42	19.9	11.7	17	14	
VPA30F ^[5] -3J	30	3	M12×1	51	20.3	10.9	14	12	
VPA30F ^[5] -4J ^[9]		4							
VPA30F ^[5] -6J ^[9]		6	M14×1	42	19.9	11.7	17	14	

※ [5] : Replaced with Pad rubber material code. Refer to page 916 for details.

※ [9] : Replaced with "-S3" for -S3 spec. (Copper alloy free material for metal parts and FKM or HNBR for sealing parts). -S3 spec. is available for model codes with [9] in the table above.

※ Pad material N and NE are not suitable for use under ozone environment.

※ Tightening torque of a pad holder fixing bulkhead nut is as followings. Pad O.D. : ø10, ø15mm ▶ 12~14N·m. Pad O.D. : ø20~ø30mm ▶ 18~21N·m.

VPA Fixed type / Top port / Baro fitting / Standard holder

RoHS Compliant Copper alloy free available  CAD (2D&3D)

VPA10F [5][6][9]
VPA15F [5][6][9]

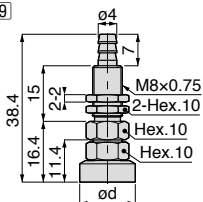

VPA20F [5][6][9]
VPA25F [5][6][9]
VPA30F [5][6][9]

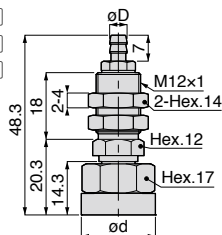

Unit : mm

Model code	Pad O.D. øD	Tube I.D. øD	Connection config. code
VPA10F [5]-6B [9]	10	—	-M4
VPA15F [5]-6B [9]	15	—	
VPA20F [5]-4B [9]	20	2.5	-M6
VPA20F [5]-6B [9]		4	
VPA25F [5]-4B [9]		2.5	
VPA25F [5]-6B [9]		4	
VPA30F [5]-4B [9]	30	2.5	
VPA30F [5]-6B [9]		4	

- ※ [5] : Replaced with Pad rubber material code. Refer to page 916 for details.
- ※ [9] : Replaced with "-S3" for -S3 spec. (Copper alloy free material for metal parts and FKM or HNBR for sealing parts).
- ※ Pad material N and NE are not suitable for use under ozone environment.
- ※ Tightening torque of a pad holder fixing bulkhead nut is as followings. Pad O.D. : ø10, ø15mm ▶ 12~14N·m. Pad O.D. : ø20~ø30mm ▶ 18~21N·m.

VPA Fixed type / Top port / Female thread / Standard holder

RoHS Compliant Copper alloy free available  CAD (2D&3D)

VPA20F [5]-M6 [9]
VPA25F [5]-M6 [9]
VPA30F [5]-M6 [9]

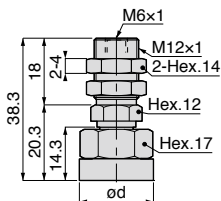

Unit : mm

Model code	Pad O.D. øD	Connection config. code
VPA20F [5]-M6 [9]	20	-M6
VPA25F [5]-M6 [9]	25	
VPA30F [5]-M6 [9]	30	

- ※ [5] : Replaced with Pad rubber material code. Refer to page 916 for details.
- ※ [9] : Replaced with "-S3" for -S3 spec. (Copper alloy free material for metal parts and FKM or HNBR for sealing parts).
- ※ Pad material N and NE are not suitable for use under ozone environment.
- ※ Tightening torque of a pad holder fixing bulkhead nut is as followings. Pad O.D. : ø10, ø15mm ▶ 12~14N·m. Pad O.D. : ø20~ø30mm ▶ 18~21N·m.

VPMB Fixed type / Side port / Push-in fitting / Mini holder

RoHS Compliant Copper alloy free available CAD (2D&3D)

VPMB10F [5][6][9]

VPMB15F [5][6][9]

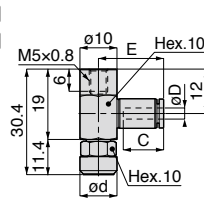

VPMB20F [5][6][9]

VPMB25F [5][6][9]

VPMB30F [5][6][9]

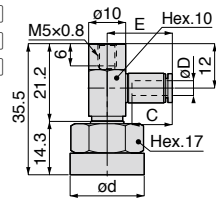

Unit : mm

Model code	Pad O.D. ød	Tube O.D. øD	E	Tube end C	Connection config. code
VPMB10F [5]-180J	10	1.8	13.7	8.4	-M4
VPMB10F [5]-2J		2			
VPMB10F [5]-3J		3			
VPMB10F [5]-4J [9]		4			
VPMB10F [5]-6J [9]		6			
VPMB15F [5]-180J	15	1.8	13.7	8.4	
VPMB15F [5]-2J		2			
VPMB15F [5]-3J		3			
VPMB15F [5]-4J [9]		4			
VPMB15F [5]-6J [9]		6			
VPMB20F [5]-180J	20	1.8	13.7	8.4	-M6
VPMB20F [5]-2J		2			
VPMB20F [5]-3J		3			
VPMB20F [5]-4J [9]		4			
VPMB20F [5]-6J [9]		6			
VPMB25F [5]-180J	25	1.8	13.7	8.4	
VPMB25F [5]-2J		2			
VPMB25F [5]-3J		3			
VPMB25F [5]-4J [9]		4			
VPMB25F [5]-6J [9]		6			
VPMB30F [5]-180J	30	1.8	13.7	8.4	
VPMB30F [5]-2J		2			
VPMB30F [5]-3J		3			
VPMB30F [5]-4J [9]		4			
VPMB30F [5]-6J [9]		6			

※ [5] : Replaced with Pad rubber material code. Refer to page 916 for details.

※ [9] : Replaced with "-S3" for -S3 spec. (Copper alloy free material for metal parts and FKM or HNBR for sealing parts). -S3 spec. is available for model codes with [9] in the table above.

※ Pad material N and NE are not suitable for use under ozone environment.

VPMB Fixed type / Side port / Baro fitting / Mini holder

RoHS Compliant Copper alloy free available CAD (2D&3D)

VPMB10F [5][6][9]

VPMB15F [5][6][9]

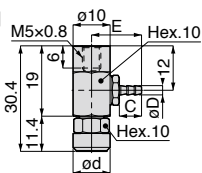

VPMB20F [5][6][9]

VPMB25F [5][6][9]

VPMB30F [5][6][9]

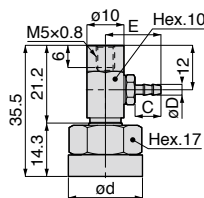

Unit : mm

Model code	Tube I.D. øD	Pad O.D. ød	E	C	Connection config. code
VPMB10F[5]-3B[9]	2	10	13.4	6	-M4
VPMB10F[5]-4B[9]	2.5		14.9	7	
VPMB10F[5]-6B[9]	4		13.4	6	
VPMB15F[5]-3B[9]	2	15	14.9	7	
VPMB15F[5]-4B[9]	2.5		13.4	6	
VPMB15F[5]-6B[9]	4		14.9	7	
VPMB20F[5]-3B[9]	2	20	13.4	6	-M6
VPMB20F[5]-4B[9]	2.5		14.9	7	
VPMB20F[5]-6B[9]	4		13.4	6	
VPMB25F[5]-3B[9]	2	25	14.9	7	
VPMB25F[5]-4B[9]	2.5		13.4	6	
VPMB25F[5]-6B[9]	4		14.9	7	
VPMB30F[5]-3B[9]	2	30	13.4	6	
VPMB30F[5]-4B[9]	2.5		14.9	7	
VPMB30F[5]-6B[9]	4		13.4	6	

※ [5] : Replaced with Pad rubber material code. Refer to page 916 for details.

※ [9] : Replaced with "-S3" for -S3 spec. (Copper alloy free material for metal parts and FKM or HNBR for sealing parts).

※ .Pad material N and NE are not suitable for use under ozone environment.

VPMB Fixed type / Side port / Female thread / Mini holder

RoHS Compliant Copper alloy free available CAD (2D&3D)

VPMB10F [5]-M5[9]

VPMB15F [5]-M5[9]

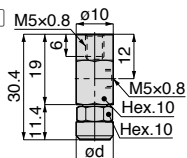

VPMB20F [5]-M5[9]

VPMB25F [5]-M5[9]

VPMB30F [5]-M5[9]

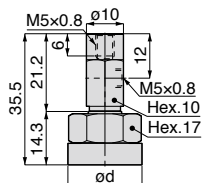

Unit : mm

Model code	Pad O.D. ød	Connection config. code
VPMB10F[5]-M5[9]	10	-M4
VPMB15F[5]-M5[9]	15	
VPMB20F[5]-M5[9]	20	
VPMB25F[5]-M5[9]	25	-M6
VPMB30F[5]-M5[9]	30	

※ [5] : Replaced with Pad rubber material code. Refer to page 916 for details.

※ [9] : Replaced with "-S3" for -S3 spec. (Copper alloy free material for metal parts and FKM or HNBR for sealing parts).

※ .Pad material N and NE are not suitable for use under ozone environment.

VPB Fixed type / Side port / Push-in fitting / Standard holder

RoHS Compliant Copper alloy free available CAD (2D&3D)

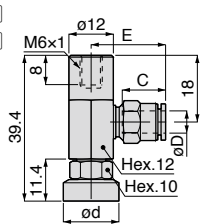

VPB20F [5][6][9]
VPB25F [5][6][9]
VPB30F [5][6][9]

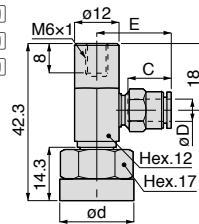

Unit : mm

Model code	Pad O.D. ød	Tube O.D. øD	E	Tube end C	Connection config. code
VPB10F[5]-3J	10	3	18.6	10.9	-M4
VPB10F[5]-4J[9]		4			
VPB10F[5]-6J[9]		6			
VPB15F[5]-3J	15	3	18.6	10.9	
VPB15F[5]-4J[9]		4			
VPB15F[5]-6J[9]		6			
VPB20F[5]-3J	20	3	18.6	10.9	-M6
VPB20F[5]-4J[9]		4			
VPB20F[5]-6J[9]		6			
VPB25F[5]-3J	25	3	18.6	10.9	
VPB25F[5]-4J[9]		4			
VPB25F[5]-6J[9]		6			
VPB30F[5]-3J	30	3	18.6	10.9	
VPB30F[5]-4J[9]		4			
VPB30F[5]-6J[9]		6			

※ [5] : Replaced with Pad rubber material code. Refer to page 916 for details.

※ [9] : Replaced with "-S3" for -S3 spec. (Copper alloy free material for metal parts and FKM or HNBR for sealing parts). -S3 spec. is available for model codes with [9] in the table above.

※ .Pad material N and NE are not suitable for use under ozone environment.

VPB Fixed type / Side port / Baro fitting / Standard holder

RoHS Compliant Copper alloy free available  CAD (2D&3D)

VPB10F [5][6][9]

VPB15F [5][6][9]

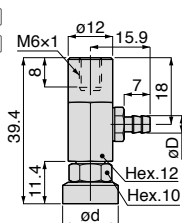

VPB20F [5][6][9]

VPB25F [5][6][9]

VPB30F [5][6][9]

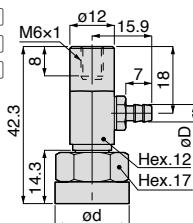

Unit : mm

Model code	Pad O.D. ød	Tube I.D. øD	Connection config. code
VPB10F[5]-4B[9]	10	2.5	-M4
VPB10F[5]-6B[9]		4	
VPB15F[5]-4B[9]		2.5	
VPB15F[5]-6B[9]		4	
VPB20F[5]-4B[9]	20	2.5	-M6
VPB20F[5]-6B[9]		4	
VPB25F[5]-4B[9]		2.5	
VPB25F[5]-6B[9]		4	
VPB30F[5]-4B[9]	30	2.5	
VPB30F[5]-6B[9]		4	

※ [5] : Replaced with Pad rubber material code. Refer to page 916 for details.

※ [9] : Replaced with "-S3" for -S3 spec. (Copper alloy free material for metal parts and FKM or HNBR for sealing parts).

※ .Pad material N and NE are not suitable for use under ozone environment.

923

VPB Fixed type / Side port / Female thread / Standard holder

RoHS Compliant Copper alloy free available  CAD (2D&3D)

VPB10F [5]-M6 [9]

VPB15F [5]-M6 [9]

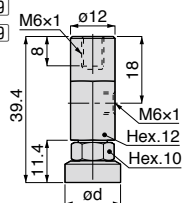

VPB20F [5]-M6 [9]

VPB25F [5]-M6 [9]

VPB30F [5]-M6 [9]

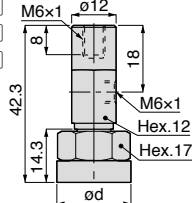

Unit : mm

Model code	Pad O.D. ød	Connection config. code
VPB10F[5]-M6[9]	10	-M4
VPB15F[5]-M6[9]	15	
VPB20F[5]-M6[9]	20	
VPB25F[5]-M6[9]	25	
VPB30F[5]-M6[9]	30	-M6

※ [5] : Replaced with Pad rubber material code. Refer to page 916 for details.

※ [9] : Replaced with "-S3" for -S3 spec. (Copper alloy free material for metal parts and FKM or HNBR for sealing parts).

※ .Pad material N and NE are not suitable for use under ozone environment.

■ Vacuum pad + Spring type holder Dimensions

VPMS Spring type Top port / Push-in fitting / Mini holder

RoHS Compliant Copper alloy free available CAD (2D&3D)

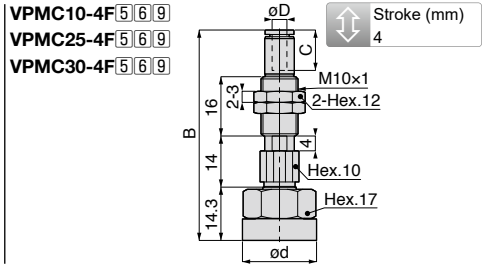
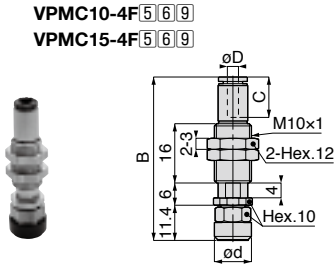

Unit : mm

Model code	Pad O.D. ød	Tube O.D. øD	B	Tube end C	Spring force (N)	Connection config. code
VPMC10-4F[5]-180J	10	1.8	42.3	8.4	1.0~1.3	-M4
VPMC10-4F[5]-2J		2				
VPMC10-4F[5]-3J		3	46.1	10.9		
VPMC10-4F[5]-4J[9]		4				
VPMC15-4F[5]-180J	15	1.8	42.3	8.4	1.0~1.3	
VPMC15-4F[5]-2J		2				
VPMC15-4F[5]-3J		3	46.1	10.9		
VPMC15-4F[5]-4J[9]		4				
VPMC20-4F[5]-180J	20	1.8	53.2	8.4	1.0~1.3	-M6
VPMC20-4F[5]-2J		2				
VPMC20-4F[5]-3J		3	57	10.9		
VPMC20-4F[5]-4J[9]		4				
VPMC25-4F[5]-180J	25	1.8	53.2	8.4	1.0~1.3	
VPMC25-4F[5]-2J		2				
VPMC25-4F[5]-3J		3	57	10.9		
VPMC25-4F[5]-4J[9]		4				
VPMC30-4F[5]-180J	30	1.8	53.2	8.4	1.0~1.3	
VPMC30-4F[5]-2J		2				
VPMC30-4F[5]-3J		3	57	10.9		
VPMC30-4F[5]-4J[9]		4				

※ [5] : Replaced with Pad rubber material code. Refer to page 916 for details.

※ [9] : Replaced with "-S3" for -S3 spec. (Copper alloy free material for metal parts and FKM or HNBR for sealing parts). -S3 spec. is available for model codes with [9] in the table above.

※ .Pad material N and NE are not suitable for use under ozone environment.

※ .Tightening torque of a pad holder fixing bulkhead nut is 4~6N·m.

VPMC **PDF Compressor Free Version** Spring type / Top port / Barf fitting / Mini holder

RoHS Compliant Copper alloy free available CAD (2D&3D)

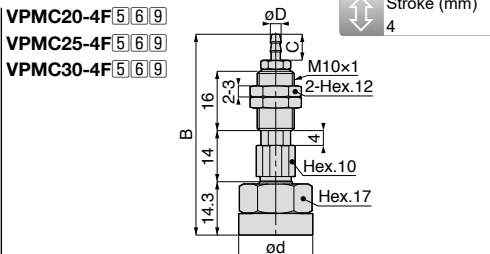
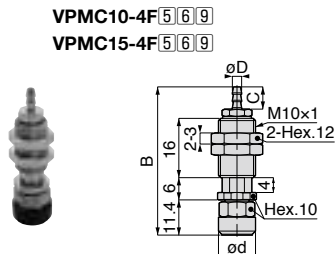

Unit : mm

Model code	Pad O.D. ød	Tube I.D. øD	B	C	Spring force (N)	Connection config. code
VPMC10-4F[5]-3B[9]	10	2	42	6	1.0 ~ 1.3	-M4
VPMC10-4F[5]-4B[9]		2.5	43.5	7		
VPMC10-4F[5]-6B[9]		4				
VPMC15-4F[5]-3B[9]	15	2	42	6	1.0 ~ 1.3	
VPMC15-4F[5]-4B[9]		2.5	43.5	7		
VPMC15-4F[5]-6B[9]		4				
VPMC20-4F[5]-3B[9]	20	2	52.9	6	1.0 ~ 1.3	-M6
VPMC20-4F[5]-4B[9]		2.5	54.4	7		
VPMC20-4F[5]-6B[9]		4				
VPMC25-4F[5]-3B[9]	25	2	52.9	6	1.0 ~ 1.3	
VPMC25-4F[5]-4B[9]		2.5	54.4	7		
VPMC25-4F[5]-6B[9]		4				
VPMC30-4F[5]-3B[9]	30	2	52.9	6	1.0 ~ 1.3	
VPMC30-4F[5]-4B[9]		2.5	54.4	7		
VPMC30-4F[5]-6B[9]		4				

※ [5] : Replaced with Pad rubber material code. Refer to page 916 for details.

※ [9] : Replaced with "-S3" for -S3 spec. (Copper alloy free material for metal parts and FKM or HNBR for sealing parts).

※ Pad material N and NE are not suitable for use under ozone environment.

※ Tightening torque of a pad holder fixing bulkhead nut is 4~6N·m.

VPC **PDI Compressor Free Version** Spring type / Top port / Push-in fitting / Standard holder

RoHS Compliant Copper alloy free available CAD (2D&3D)

VPC10 **3**F**5**6**9**

VPC15 **3**F**5**6**9**

Stroke (mm)
6, 10, 15, 20

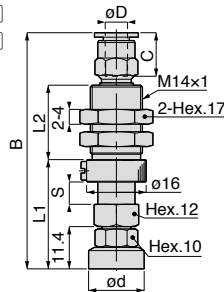

Unit : mm

Model code	Pad O.D. ød	Tube O.D. øD	B	L1	L2	Tube end C	Stroke S	Spring force (N)	Connection config. code	
VPC10-6F5-3J	10	3	62.1	29.4	20	10.9	6	4.0~7.1	-M4	
VPC10-6F5-4J9		4				11.7				
VPC10-6F5-6J9		6				11.7				
VPC10-10F5-3J		3	66.6	33.9		10.9	10	2.0~5.2		
VPC10-10F5-4J		4				11.7				
VPC10-10F5-6J		6				11.7				
VPC10-15F5-3J		3	76.6	38.9	25	10.9	15	2.0~5.9		
VPC10-15F5-4J		4				11.7				
VPC10-15F5-6J		6				11.7				
VPC10-20F5-3J		3	92.6	45.9		34	10.9	20		1.1~4.8
VPC10-20F5-4J		4					11.7			
VPC10-20F5-6J		6					11.7			
VPC15-6F5-3J	15	3	62.1	29.4	20		10.9	6	4.0~7.1	
VPC15-6F5-4J9		4					11.7			
VPC15-6F5-6J9		6					11.7			
VPC15-10F5-3J		3	66.6	33.9		10.9	10	2.0~5.2		
VPC15-10F5-4J		4				11.7				
VPC15-10F5-6J		6				11.7				
VPC15-15F5-3J		3	76.6	38.9	25	10.9	15	2.0~5.9		
VPC15-15F5-4J		4				11.7				
VPC15-15F5-6J		6				11.7				
VPC15-20F5-3J		3	92.6	45.9		34	10.9	20	1.1~4.8	
VPC15-20F5-4J		4					11.7			
VPC15-20F5-6J		6					11.7			

※ [5] : Replaced with Pad rubber material code. Refer to page 916 for details.

※ [9] : Replaced with "-S3" for -S3 spec. (Copper alloy free material for metal parts and FKM or HNBR for sealing parts). -S3 spec. is available for model codes with [9] in the table above.

※ .Pad material N and NE are not suitable for use under ozone environment.

※ .Tightening torque of a pad holder fixing bulkhead nut is as followings. Pad O.D. : ø10, ø15mm ▶ 8~10N·m. Pad O.D. : ø20~ø30mm ▶ 4.5~6N·m.

PDF Compressor Free Version

RoHS Compliant ✕ Copper alloy free available ✍ CAD (2D&3D)

VPC20³F⁵6⁹
 VPC25³F⁵6⁹
 VPC30³F⁵6⁹

Stroke (mm)
 6, 10, 15, 20

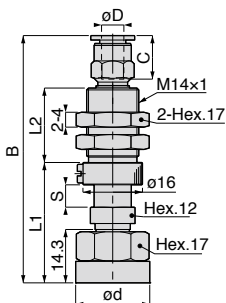

Unit : mm

Model code	Pad O.D. ød	Tube O.D. øD	B	L1	L2	Tube end C	Stroke S	Spring force (N)	Connection config. code		
VPC20-6F ⁵ -3J	20	3	65	32.3	20	10.9	6	7.0 ~ 12.6	-M6		
VPC20-6F ⁵ -4J ⁹		4									
VPC20-6F ⁵ -6J ⁹		6									
VPC20-10F ⁵ -3J		3	71			38.3	25	10.9		10	3.3 ~ 10.0
VPC20-10F ⁵ -4J		4									
VPC20-10F ⁵ -6J		6									
VPC20-15F ⁵ -3J		3	81	43.3	34			10.9		15	3.3 ~ 10.4
VPC20-15F ⁵ -4J		4									
VPC20-15F ⁵ -6J		6									
VPC20-20F ⁵ -3J		3	97			50.3	20	10.9		20	2.0 ~ 8.7
VPC20-20F ⁵ -4J		4									
VPC20-20F ⁵ -6J		6									
VPC25-6F ⁵ -3J	25	3	65	32.3	20			10.9	6	7.0 ~ 12.6	
VPC25-6F ⁵ -4J ⁹		4									
VPC25-6F ⁵ -6J ⁹		6									
VPC25-10F ⁵ -3J		3	71			38.3	25	10.9	10	3.3 ~ 10.0	
VPC25-10F ⁵ -4J		4									
VPC25-10F ⁵ -6J		6									
VPC25-15F ⁵ -3J		3	81	43.3	34			10.9	15	3.3 ~ 10.4	
VPC25-15F ⁵ -4J		4									
VPC25-15F ⁵ -6J		6									
VPC25-20F ⁵ -3J		3	97			50.3	20	10.9	20	2.0 ~ 8.7	
VPC25-20F ⁵ -4J		4									
VPC25-20F ⁵ -6J		6									

PDF Compressor Free Version

Unit : mm

Model code	Pad O.D. ød	Tube O.D. øD	B	L1	L2	Tube end C	Stroke S	Spring force (N)	Connection config. code			
VPC30-6F[5]-3J	30	3	65	32.3	20	10.9	6	7.0~12.6	-M6			
VPC30-6F[5]-4J[9]		4										
VPC30-6F[5]-6J[9]		6								66.4		
VPC30-10F[5]-3J		3	71	38.3		10.9						
VPC30-10F[5]-4J		4										
VPC30-10F[5]-6J		6								72.4		
VPC30-15F[5]-3J		3	81	43.3	25	10.9	15	3.3~10.4				
VPC30-15F[5]-4J		4										
VPC30-15F[5]-6J		6								82.4		
VPC30-20F[5]-3J		3	97	50.3		34				10.9	20	2.0~8.7
VPC30-20F[5]-4J		4										
VPC30-20F[5]-6J		6										

※ [5] : Replaced with Pad rubber material code. Refer to page 916 for details.

※ [9] : Replaced with "-S3" for -S3 spec. (Copper alloy free material for metal parts and FKM or HNBR for sealing parts). -S3 spec. is available for model codes with [9] in the table above.

※ .Pad material N and NE are not suitable for use under ozone environment.

※ .Tightening torque of a pad holder fixing bulkhead nut is as followings. Pad O.D. : ø10, ø15mm ▶ 8~10N·m. Pad O.D. : ø20~ø30mm ▶ 4.5~6N·m.

VPC PDF Compressor Free Version
Spring type / Top port / Barf fitting / Standard holder

RoHS Compliant Copper alloy free available  CAD (2D&3D)

Stroke (mm)
6,10,15,20

VPC10 3 F 5 6 9
VPC15 3 F 5 6 9

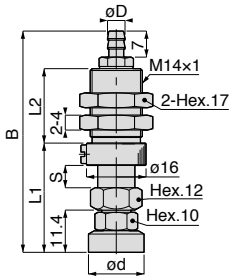

VPC20 3 F 5 6 9
VPC25 3 F 5 6 9
VPC30 3 F 5 6 9

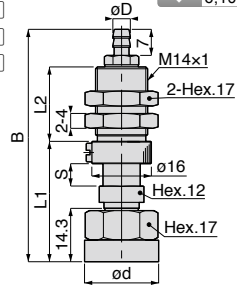

Unit : mm

Model code	Pad O.D. øD	Tube I.D. øD	B	L1	L2	Stroke S	Spring force (N)	Connection config. code
VPC10-6F 5-4B 9	10	2.5	59.5	29.4	20	6	4.0~7.1	-M4
VPC10-6F 5-6B 9		4						
VPC10-10F 5-4B		2.5	64	33.9		10	2.0~5.2	
VPC10-10F 5-6B		4						
VPC10-15F 5-4B		2.5	74	38.9	25	15	2.0~5.9	
VPC10-15F 5-6B		4						
VPC10-20F 5-4B	2.5	90	45.9	34	20	1.1~4.8		
VPC10-20F 5-6B	4							
VPC15-6F 5-4B 9	15	2.5	59.5	29.4	20	6	4.0~7.1	
VPC15-6F 5-6B 9		4						
VPC15-10F 5-4B		2.5	64	33.9		10	2.0~5.2	
VPC15-10F 5-6B		4						
VPC15-15F 5-4B		2.5	74	38.9	25	15	2.0~5.9	
VPC15-15F 5-6B		4						
VPC15-20F 5-4B	2.5	90	45.9	34	20	1.1~4.8		
VPC15-20F 5-6B	4							
VPC20-6F 5-4B 9	20	2.5	62.4	32.3	20	6	7.0~12.6	-M6
VPC20-6F 5-6B 9		4						
VPC20-10F 5-4B		2.5	68.4	38.3		10	3.3~10.0	
VPC20-10F 5-6B		4						
VPC20-15F 5-4B		2.5	78.4	43.3	25	15	3.3~10.4	
VPC20-15F 5-6B		4						
VPC20-20F 5-4B	2.5	94.4	50.3	34	20	2.0~8.7		
VPC20-20F 5-6B	4							
VPC25-6F 5-4B 9	25	2.5	62.4	32.3	20	6	7.0~12.6	
VPC25-6F 5-6B 9		4						
VPC25-10F 5-4B		2.5	68.4	38.3		10	3.3~10.0	
VPC25-10F 5-6B		4						
VPC25-15F 5-4B		2.5	78.4	43.3	25	15	3.3~10.4	
VPC25-15F 5-6B		4						
VPC25-20F 5-4B	2.5	94.4	50.3	34	20	2.0~8.7		
VPC25-20F 5-6B	4							

PDF Compressor Free Version

Unit : mm

Model code	Pad O.D. ød	Tube I.D. øD	B	L1	L2	Stroke S	Spring force (N)	Connection config. code
VPC30-6F[5]-4B[9]	30	2.5	62.4	32.3	20	6	7.0~12.6	-M6
VPC30-6F[5]-6B[9]		4						
VPC30-10F[5]-4B		2.5	68.4	38.3				
VPC30-10F[5]-6B		4						
VPC30-15F[5]-4B		2.5	78.4	43.3	25	15	3.3~10.4	
VPC30-15F[5]-6B		4						
VPC30-20F[5]-4B		2.5	94.4	50.3	34	20	2.0~8.7	
VPC30-20F[5]-6B		4						

※ [5] : Replaced with Pad rubber material code. Refer to page 916 for details.

※ [9] : Replaced with "-S3" for -S3 spec. (Copper alloy free material for metal parts and FKM or HNBR for sealing parts). -S3 spec. is available for model codes with [9] in the table above.

※ .Pad material N and NE are not suitable for use under ozone environment.

※ .Tightening torque of a pad holder fixing bulkhead nut is as followings. Pad O.D. : ø10, ø15mm ▶ 8~10N·m. Pad O.D. : ø20~ø30mm ▶ 4.5~6N·m.

VPC Spring type / Top port / Female thread / Standard holder

RoHS Compliant Copper alloy free available  CAD (2D&3D)

Stroke (mm)
6, 10, 15, 20

VPC10-6F[5]-M6[9]
VPC15-6F[5]-M6[9]

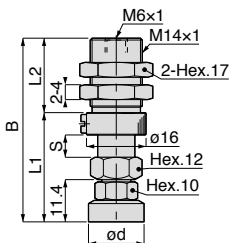

VPC20-6F[5]-M6[9]
VPC25-6F[5]-M6[9]
VPC30-6F[5]-M6[9]

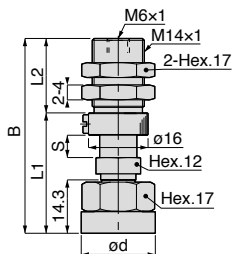

Unit : mm

Model code	Pad O.D. ød	B	L1	L2	Stroke S	Spring force (N)	Connection config. code
VPC10-6F[5]-M6[9]	10	49.4	29.4	20	6	4.0~7.1	-M4
VPC10-10F[5]-M6		53.9	33.9		10	2.0~5.2	
VPC10-15F[5]-M6		63.9	38.9	25	15	2.0~5.9	
VPC10-20F[5]-M6		79.9	45.9	34	20	1.1~4.8	
VPC15-6F[5]-M6[9]	15	49.4	29.4	20	6	4.0~7.1	
VPC15-10F[5]-M6		53.9	33.9		10	2.0~5.2	
VPC15-15F[5]-M6		63.9	38.9	25	15	2.0~5.9	
VPC15-20F[5]-M6		79.9	45.9	34	20	1.1~4.8	
VPC20-6F[5]-M6[9]	20	52.3	32.3	20	6	7.0~12.6	-M6
VPC20-10F[5]-M6		58.3	38.3		10	3.3~10.0	
VPC20-15F[5]-M6		68.3	43.3	25	15	3.3~10.4	
VPC20-20F[5]-M6		84.3	50.3	34	20	2.0~8.7	
VPC25-6F[5]-M6[9]	25	52.3	32.3	20	6	7.0~12.6	
VPC25-10F[5]-M6		58.3	38.3		10	3.3~10.0	
VPC25-15F[5]-M6		68.3	43.3	25	15	3.3~10.4	
VPC25-20F[5]-M6		84.3	50.3	34	20	2.0~8.7	
VPC30-6F[5]-M6[9]	30	52.3	32.3	20	6	7.0~12.6	
VPC30-10F[5]-M6		58.3	38.3		10	3.3~10.0	
VPC30-15F[5]-M6		68.3	43.3	25	15	3.3~10.4	
VPC30-20F[5]-M6		84.3	50.3	34	20	2.0~8.7	

※ [5] : Replaced with Pad rubber material code. Refer to page 916 for details.

※ [9] : Replaced with "-S3" for -S3 spec. (Copper alloy free material for metal parts and FKM or HNBR for sealing parts). -S3 spec. is available for model codes with [9] in the table above.

※ Pad material N and NE are not suitable for use under ozone environment.

※ Tightening torque of a pad holder fixing bulkhead nut is as followings. Pad O.D. : ø10, ø15mm ▶ 8~10N·m. Pad O.D. : ø20~ø30mm ▶ 4.5~6N·m.

VPOC Spring type / Top port / Push-in fitting / No cover holder

VPOC20 3 F 5 6

VPOC25 3 F 5 6

VPOC30 3 F 5 6

RoHS Compliant CAD (2D&3D)

Stroke (mm)
20,30,40,50

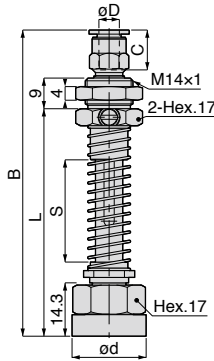

- ※ [5] : Replaced with Pad rubber material code. Refer to page 916 for details.
- ※ : Tightening torque of a pad holder fixing bulkhead nut is 4.5~6N·m.

Unit : mm

Model code	Pad O.D. ød	Tube O.D. øD	B	L	Tube end C	Stroke S	Spring force (N)	Connection config. code		
VPOC20-20F[5]-3J	20	3	74	52.3	10.9	20	1.5~4.9			
VPOC20-20F[5]-4J		4			11.7					
VPOC20-20F[5]-6J		6			11.7					
VPOC20-30F[5]-3J		3	87		65.3	10.9			30	1.1~4.8
VPOC20-30F[5]-4J		4				11.7				
VPOC20-30F[5]-6J		6				11.7				
VPOC20-40F[5]-3J		3	100	78.3		10.9	40		1.0~4.5	
VPOC20-40F[5]-4J		4				11.7				
VPOC20-40F[5]-6J		6				11.7				
VPOC20-50F[5]-3J		3	113		91.3	10.9	50			0.9~4.5
VPOC20-50F[5]-4J		4				11.7				
VPOC20-50F[5]-6J		6				11.7				
VPOC25-20F[5]-3J	25	3	74	52.3		10.9	20	1.5~4.9		
VPOC25-20F[5]-4J		4				11.7				
VPOC25-20F[5]-6J		6				11.7				
VPOC25-30F[5]-3J		3	87		65.3	10.9	30		1.1~4.8	
VPOC25-30F[5]-4J		4				11.7				
VPOC25-30F[5]-6J		6				11.7				
VPOC25-40F[5]-3J		3	100	78.3		10.9	40	1.0~4.5		
VPOC25-40F[5]-4J		4				11.7				
VPOC25-40F[5]-6J		6				11.7				
VPOC25-50F[5]-3J		3	113		91.3	10.9	50		0.9~4.5	
VPOC25-50F[5]-4J		4				11.7				
VPOC25-50F[5]-6J		6				11.7				
VPOC30-20F[5]-3J	30	3	74	52.3		10.9	20	1.5~4.9		
VPOC30-20F[5]-4J		4				11.7				
VPOC30-20F[5]-6J		6				11.7				
VPOC30-30F[5]-3J		3	87		65.3	10.9	30		1.1~4.8	
VPOC30-30F[5]-4J		4				11.7				
VPOC30-30F[5]-6J		6				11.7				
VPOC30-40F[5]-3J		3	100	78.3		10.9	40	1.0~4.5		
VPOC30-40F[5]-4J		4				11.7				
VPOC30-40F[5]-6J		6				11.7				
VPOC30-50F[5]-3J		3	113		91.3	10.9	50		0.9~4.5	
VPOC30-50F[5]-4J		4				11.7				
VPOC30-50F[5]-6J		6				11.7				

VPOC Spring type - Top port / Baro fitting / No cover holder

VPOC20 3 F 5 6

VPOC25 3 F 5 6

VPOC30 3 F 5 6

RoHS Compliant CAD (2D&3D)

Stroke (mm)
20,30,40,50

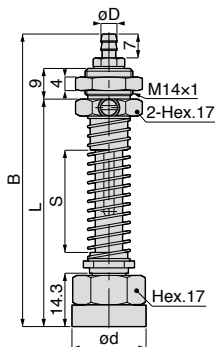

Unit : mm

Model code	Pad O.D. ød	Tube I.D. øD	B	L	Stroke S	Spring force (N)	Connection config. code		
VPOC20-20F[5]-4B	20	2.5	71.4	52.3	20	1.5~4.9	-M6		
VPOC20-20F[5]-6B		4							
VPOC20-30F[5]-4B		2.5	84.4					65.3	
VPOC20-30F[5]-6B		4							
VPOC20-40F[5]-4B		2.5	97.4						78.3
VPOC20-40F[5]-6B		4							
VPOC20-50F[5]-4B	2.5	110.4	91.3						
VPOC20-50F[5]-6B	4								
VPOC25-20F[5]-4B	25	2.5		71.4	52.3	20		1.5~4.9	
VPOC25-20F[5]-6B		4							
VPOC25-30F[5]-4B		2.5		84.4					65.3
VPOC25-30F[5]-6B		4							
VPOC25-40F[5]-4B		2.5	97.4	78.3					
VPOC25-40F[5]-6B		4							
VPOC25-50F[5]-4B	2.5	110.4	91.3						
VPOC25-50F[5]-6B	4								
VPOC30-20F[5]-4B	30	2.5			71.4	52.3		20	1.5~4.9
VPOC30-20F[5]-6B		4							
VPOC30-30F[5]-4B		2.5		84.4	65.3				
VPOC30-30F[5]-6B		4							
VPOC30-40F[5]-4B		2.5	97.4	78.3					
VPOC30-40F[5]-6B		4							
VPOC30-50F[5]-4B	2.5	110.4	91.3						
VPOC30-50F[5]-6B	4								

※ [5] : Replaced with Pad rubber material code. Refer to page 916 for details.

※ : Tightening torque of a pad holder fixing bulkhead nut is 4.5~6N·m.

VPOC **3** **F** **5** -M6 **3** **F** **5** -M6 **3** **F** **5** -M6
DI Compressor Free Version Spring type / Top port / Female thread / No cover holder

RoHS Compliant CAD (2D&3D)



VPOC20**3**F**5**-M6
 VPOC25**3**F**5**-M6
 VPOC30**3**F**5**-M6

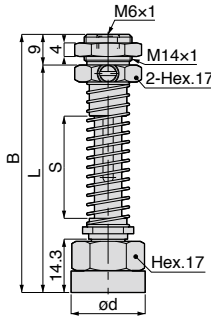

Stroke (mm)
 20,30,40,50

Unit : mm

Model code	Pad O.D. ød	B	L	Stroke S	Spring force (N)	Connection config. code
VPOC20-20F5-M6	20	61.3	52.3	20	1.5~4.9	-M6
VPOC20-30F5-M6		74.3	65.3	30	1.1~4.8	
VPOC20-40F5-M6		87.3	78.3	40	1.0~4.5	
VPOC20-50F5-M6		100.3	91.3	50	0.9~4.5	
VPOC25-20F5-M6	25	61.3	52.3	20	1.5~4.9	
VPOC25-30F5-M6		74.3	65.3	30	1.1~4.8	
VPOC25-40F5-M6		87.3	78.3	40	1.0~4.5	
VPOC25-50F5-M6		100.3	91.3	50	0.9~4.5	
VPOC30-20F5-M6	30	61.3	52.3	20	1.5~4.9	
VPOC30-30F5-M6		74.3	65.3	30	1.1~4.8	
VPOC30-40F5-M6		87.3	78.3	40	1.0~4.5	
VPOC30-50F5-M6		100.3	91.3	50	0.9~4.5	

※ [5] : Replaced with Pad rubber material code. Refer to page 916 for details.

※ . Tightening torque of a pad holder fixing bulkhead nut is 4.5~6N·m.

VPMD PDF Compressor Free Version
Spring type / Side port / Push-in fitting / Mini holder

RoHS Compliant Copper alloy free available  CAD (2D&3D)

Stroke (mm)
4

VPMD10-4F [5] [6] [9]
VPMD15-4F [5] [6] [9]

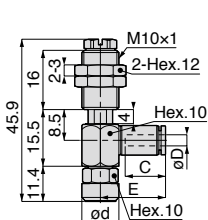

VPMD20-4F [5] [6] [9]
VPMD25-4F [5] [6] [9]
VPMD30-4F [5] [6] [9]

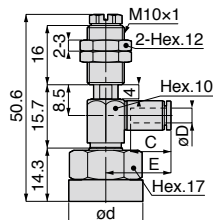

Unit : mm

Model code	Pad O.D. ød	Tube O.D. øD	E	Tube end C	Spring force (N)	Connection config. code
VPMD10-4F [5]-180J	10	1.8	13.7	8.4	1.0 ~ 1.3	-M4
VPMD10-4F [5]-2J		2				
VPMD10-4F [5]-3J		3				
VPMD10-4F [5]-4J [9]		4				
VPMD10-4F [5]-6J [9]		6				
VPMD15-4F [5]-180J	15	1.8	13.7	8.4	1.0 ~ 1.3	
VPMD15-4F [5]-2J		2				
VPMD15-4F [5]-3J		3				
VPMD15-4F [5]-4J [9]		4				
VPMD15-4F [5]-6J [9]		6				
VPMD20-4F [5]-180J	20	1.8	13.7	8.4	1.0 ~ 1.3	
VPMD20-4F [5]-2J		2				
VPMD20-4F [5]-3J		3				
VPMD20-4F [5]-4J [9]		4				
VPMD20-4F [5]-6J [9]		6				
VPMD25-4F [5]-180J	25	1.8	13.7	8.4	1.0 ~ 1.3	-M6
VPMD25-4F [5]-2J		2				
VPMD25-4F [5]-3J		3				
VPMD25-4F [5]-4J [9]		4				
VPMD25-4F [5]-6J [9]		6				
VPMD30-4F [5]-180J	30	1.8	13.7	8.4	1.0 ~ 1.3	
VPMD30-4F [5]-2J		2				
VPMD30-4F [5]-3J		3				
VPMD30-4F [5]-4J [9]		4				
VPMD30-4F [5]-6J [9]		6				

※ [5] : Replaced with Pad rubber material code. Refer to page 916 for details.

※ [9] : Replaced with "-S3" for -S3 spec. (Copper alloy free material for metal parts and FKM or HNBR for sealing parts). -S3 spec. is available for model codes with [9] in the table above.

※ Pad material N and NE are not suitable for use under ozone environment.

※ Tightening torque of a pad holder fixing bulkhead nut is 4~6N·m.

VPMD **DC Compressor Free Version** Spring type / Side port / Barb fitting / Mini holder

RoHS Compliant Copper alloy free available CAD (2D&3D)

Stroke (mm)
4

VPMD10-4F^[5][6]^[9]
 VPMD15-4F^[5][6]^[9]

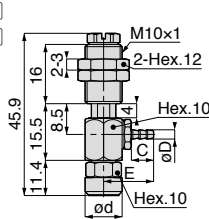

VPMD20-4F^[5][6]^[9]
 VPMD25-4F^[5][6]^[9]
 VPMD30-4F^[5][6]^[9]

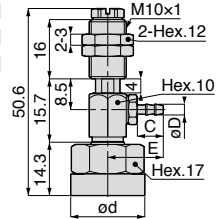

Unit : mm

Model code	Pad O.D. ød	Tube I.D. øD	E	C	Spring force (N)	Connection config. code
VPMD10-4F ^[5] -3B ^[9]	10	2	13.4	6	1.0~1.3	-M4
VPMD10-4F ^[5] -4B ^[9]		2.5	14.9	7		
VPMD10-4F ^[5] -6B ^[9]		4				
VPMD15-4F ^[5] -3B ^[9]	15	2	13.4	6	1.0~1.3	
VPMD15-4F ^[5] -4B ^[9]		2.5	14.9	7		
VPMD15-4F ^[5] -6B ^[9]		4				
VPMD20-4F ^[5] -3B ^[9]	20	2	13.4	6	1.0~1.3	-M6
VPMD20-4F ^[5] -4B ^[9]		2.5	14.9	7		
VPMD20-4F ^[5] -6B ^[9]		4				
VPMD25-4F ^[5] -3B ^[9]	25	2	13.4	6	1.0~1.3	
VPMD25-4F ^[5] -4B ^[9]		2.5	14.9	7		
VPMD25-4F ^[5] -6B ^[9]		4				
VPMD30-4F ^[5] -3B ^[9]	30	2	13.4	6	1.0~1.3	
VPMD30-4F ^[5] -4B ^[9]		2.5	14.9	7		
VPMD30-4F ^[5] -6B ^[9]		4				

- ※ [5] : Replaced with Pad rubber material code. Refer to page 916 for details.
- ※ [9] : Replaced with "-S3" for -S3 spec. (Copper alloy free material for metal parts and FKM or HNBR for sealing parts).
- ※ .Pad material N and NE are not suitable for use under ozone environment.
- ※ .Tightening torque of a pad holder fixing bulkhead nut is 4~6N·m.

VPMD **PDF Compressor Free Version** Spring type / Side port / Female thread / Mini holder

RoHS Compliant Copper alloy free available  CAD (2D&3D)

 Stroke (mm)
4

VPMD10-4F^[5]-**M5**^[9]
VPMD15-4F^[5]-**M5**^[9]

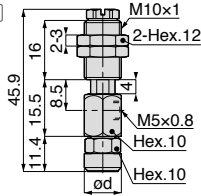

VPMD20-4F^[5]-**M5**^[9]
VPMD25-4F^[5]-**M5**^[9]
VPMD30-4F^[5]-**M5**^[9]

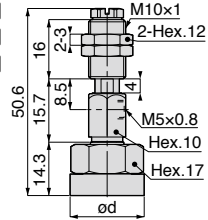

Unit : mm

Model code	Pad O.D. ød	Spring force (N)	Connection config. code
VPMD10-4F ^[5] -M5 ^[9]	10	1.0~1.3	-M4
VPMD15-4F ^[5] -M5 ^[9]	15	1.0~1.3	
VPMD20-4F ^[5] -M5 ^[9]	20	1.0~1.3	
VPMD25-4F ^[5] -M5 ^[9]	25	1.0~1.3	-M6
VPMD30-4F ^[5] -M5 ^[9]	30	1.0~1.3	

- ※ [5] : Replaced with Pad rubber material code. Refer to page 916 for details.
- ※ [9] : Replaced with "-S3" for -S3 spec. (Copper alloy free material for metal parts and FKM or HNBR for sealing parts).
- ※ Pad material N and NE are not suitable for use under ozone environment.
- ※ Tightening torque of a pad holder fixing bulkhead nut is 4~6N·m.

VPD **PDF** Compressor Side port Push-in fitting / Standard holder

RoHS Compliant Copper alloy free available CAD (2D&3D)

VPD10³F⁵6⁶9

VPD15³F⁵6⁶9

Stroke (mm)
6, 10, 15, 20

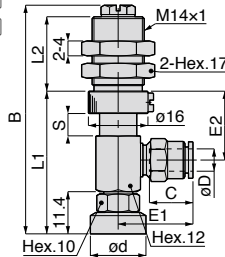

Unit : mm

Model code	Pad O.D. ød	Tube O.D. øD	B	L1	L2	E1	E2	Tube end C	Stroke S	Spring force (N)	Connection config. code
VPD10-6F ⁵ -3J	10	3	61.5	38.4	20	18.6	18.5	10.9	6	4.0~7.1	-M4
VPD10-6F ⁵ -4J ⁹		4									
VPD10-6F ⁵ -6J ⁹		6									
VPD10-10F ⁵ -3J		3	66.5	43.4		18.6	25	10.9	10	2.0~5.2	
VPD10-10F ⁵ -4J		4									
VPD10-10F ⁵ -6J		6									
VPD10-15F ⁵ -3J		3	76.5	48.4	25	18.6	30	10.9	15	2.0~5.9	
VPD10-15F ⁵ -4J		4									
VPD10-15F ⁵ -6J		6									
VPD10-20F ⁵ -3J		3	92.5	55.4	34	18.6	37	10.9	20	1.1~4.8	
VPD10-20F ⁵ -4J		4									
VPD10-20F ⁵ -6J		6									
VPD15-6F ⁵ -3J	15	3	61.5	38.4	20	18.6	18.5	10.9	6	4.0~7.1	
VPD15-6F ⁵ -4J ⁹		4									
VPD15-6F ⁵ -6J ⁹		6									
VPD15-10F ⁵ -3J		3	66.5	43.4		18.6	25	10.9	10	2.0~5.2	
VPD15-10F ⁵ -4J		4									
VPD15-10F ⁵ -6J		6									
VPD15-15F ⁵ -3J		3	76.5	48.4	25	18.6	30	10.9	15	2.0~5.9	
VPD15-15F ⁵ -4J		4									
VPD15-15F ⁵ -6J		6									
VPD15-20F ⁵ -3J		3	92.5	55.4	34	18.6	37	10.9	20	1.1~4.8	
VPD15-20F ⁵ -4J		4									
VPD15-20F ⁵ -6J		6									

※ [5] : Replaced with Pad rubber material code. Refer to page 916 for details.

※ [9] : Replaced with "-S3" for -S3 spec. (Copper alloy free material for metal parts and FKM or HNBR for sealing parts). -S3 spec. is available for model codes with [9] in the table above.

※ .Pad material N and NE are not suitable for use under ozone environment.

※ .Tightening torque of a pad holder fixing bulkhead nut is as followings. Pad O.D. : ø10, ø15mm ▶ 8~10N·m. Pad O.D., ø20~ø30mm ▶ 4.5~6N·m.

PDF Compressor Free Version

VPD20 3 F 5 6 9

VPD25 3 F 5 6 9

VPD30 3 F 5 6 9

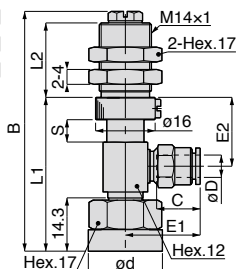

RoHS Compliant ✕ Copper alloy free available ✂ CAD (2D&3D)

Stroke (mm)
6, 10, 15, 20

Unit : mm

Model code	Pad O.D. ød	Tube O.D. øD	B	L1	L2	E1	E2	Tube end C	Stroke S	Spring force (N)	Connection config. code			
VPD20-6F5-3J	20	3	64.4	41.3	20	18.6	18.5	10.9	6	7.0~12.6	-M6			
VPD20-6F5-4J9		4						11.7						
VPD20-6F5-6J9		6				11.7								
VPD20-10F5-3J		3	70.4	47.3		25	18.6	24.5				10.9	10	3.3~10.0
VPD20-10F5-4J		4										11.7		
VPD20-10F5-6J		6					11.7							
VPD20-15F5-3J		3	80.4	52.3	34		18.6	29.5	10.9	15		3.3~10.4		
VPD20-15F5-4J		4							11.7					
VPD20-15F5-6J		6					11.7							
VPD20-20F5-3J		3	96.4	59.3		20	18.6	36.5	10.9				20	2.0~8.7
VPD20-20F5-4J		4							11.7					
VPD20-20F5-6J		6					11.7							
VPD25-6F5-3J	25	3	64.4	41.3	20		18.6	18.5	10.9	6	7.0~12.6			
VPD25-6F5-4J9		4							11.7					
VPD25-6F5-6J9		6					11.7							
VPD25-10F5-3J		3	70.4	47.3		25	18.6	24.5	10.9			10	3.3~10.0	
VPD25-10F5-4J		4							11.7					
VPD25-10F5-6J		6					11.7							
VPD25-15F5-3J		3	80.4	52.3	34		18.6	29.5	10.9	15	3.3~10.4			
VPD25-15F5-4J		4							11.7					
VPD25-15F5-6J		6					11.7							
VPD25-20F5-3J		3	96.4	59.3		20	18.6	36.5	10.9			20	2.0~8.7	
VPD25-20F5-4J		4							11.7					
VPD25-20F5-6J		6					11.7							

PDF Compressor Free Version

Unit : mm

Model code	Pad O.D. ød	Tube O.D. øD	B	L1	L2	E1	E2	Tube end C	Stroke S	Spring force (N)	Connection config. code
VPD30-6F[5]-3J	30	3	64.4	41.3	20	18.6	18.5	10.9	6	7.0~12.6	-M6
VPD30-6F[5]-4J[9]		4									
VPD30-6F[5]-6J[9]		6									
VPD30-10F[5]-3J		3	70.4	47.3		18.6	24.5	10.9			
VPD30-10F[5]-4J		4									
VPD30-10F[5]-6J		6									
VPD30-15F[5]-3J		3	80.4	52.3	25	18.6	29.5	10.9	15	3.3~10.4	
VPD30-15F[5]-4J		4									
VPD30-15F[5]-6J		6									
VPD30-20F[5]-3J		3	96.4	59.3	34	18.6	36.5	10.9	20	2.0~8.7	
VPD30-20F[5]-4J		4									
VPD30-20F[5]-6J		6									

※ [5] : Replaced with Pad rubber material code. Refer to page 916 for details.

※ [9] : Replaced with "-S3" for -S3 spec. (Copper alloy free material for metal parts and FKM or HNBR for sealing parts). -S3 spec. is available for model codes with [9] in the table above.

※ .Pad material N and NE are not suitable for use under ozone environment.

※ .Tightening torque of a pad holder fixing bulkhead nut is as followings. Pad O.D. : ø10, ø15mm ▶ 8~10N·m. Pad O.D. : ø20~ø30mm ▶ 4.5~6N·m.

VPD Spring type / Side port / Barb fitting / Standard holder

RoHS Compliant Copper alloy free available  CAD (2D&3D)

Stroke (mm)
6, 10, 15, 20

VPD10-3F569
VPD15-3F569

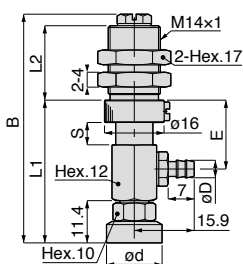

VPD20-3F569
VPD25-3F569
VPD30-3F569

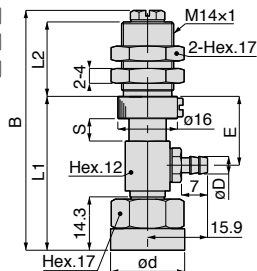

Unit : mm

Model code	Pad O.D. ød	Tube I.D. øD	B	L1	L2	E	Stroke S	Spring force (N)	Connection config. code		
VPD10-6F5-4B9	10	2.5	61.5	38.4	20	18.5	6	4.0~7.1	-M4		
VPD10-6F5-6B9		4									
VPD10-10F5-4B		2.5	66.5	43.4		25	10	2.0~5.2			
VPD10-10F5-6B		4									
VPD10-15F5-4B		2.5	76.5	48.4		25	30	15		2.0~5.9	
VPD10-15F5-6B		4									
VPD10-20F5-4B		2.5	92.5	55.4	34	37	20	1.1~4.8			
VPD10-20F5-6B		4									
VPD15-6F5-4B9		15	2.5	61.5	38.4	20	18.5	6		4.0~7.1	
VPD15-6F5-6B9			4								
VPD15-10F5-4B			2.5	66.5	43.4		25	30		15	2.0~5.9
VPD15-10F5-6B			4								
VPD15-15F5-4B	2.5		76.5	48.4	25		30	15	2.0~5.9		
VPD15-15F5-6B	4										
VPD15-20F5-4B	2.5		92.5	55.4	34	37	20	1.1~4.8			
VPD15-20F5-6B	4										
VPD20-6F5-4B9	20		2.5	64.4	41.3	20	18.5	6	7.0~12.6	-M6	
VPD20-6F5-6B9			4								
VPD20-10F5-4B			2.5	70.4	47.3		25	24.5	10		3.3~10.0
VPD20-10F5-6B			4								
VPD20-15F5-4B		2.5	80.4	52.3	25		29.5	15	3.3~10.4		
VPD20-15F5-6B		4									
VPD20-20F5-4B		2.5	96.4	59.3	34	36.5	20	2.0~8.7			
VPD20-20F5-6B		4									

※ [5]: Replaced with Pad rubber material code. Refer to page 916 for details.

※ [9]: Replaced with "-S3" for -S3 spec. (Copper alloy free material for metal parts and FKM or HNBR for sealing parts). -S3 spec. is available for model codes with [9] in the table above.

※ Pad material N and NE are not suitable for use under ozone environment.

※ Tightening torque of a pad holder fixing bulkhead nut is as followings. Pad O.D. : ø10, ø15mm ▶ 8~10N·m. Pad O.D. : ø20~ø30mm ▶ 4.5~6N·m.

PDF Compressor Free Version

Unit : mm

Model code	Pad O.D. ød	Tube I.D. øD	B	L1	L2	E	Stroke S	Spring force (N)	Connection config. code
VPD25-6F[5]-4B[9]	25	2.5	64.4	41.3	20	18.5	6	7.0~12.6	-M6
VPD25-6F[5]-6B[9]		4							
VPD25-10F[5]-4B		2.5	70.4	47.3		24.5	10	3.3~10.0	
VPD25-10F[5]-6B		4							
VPD25-15F[5]-4B		2.5	80.4	52.3	25	29.5	15	3.3~10.4	
VPD25-15F[5]-6B		4							
VPD25-20F[5]-4B		2.5	96.4	59.3	34	36.5	20	2.0~8.7	
VPD25-20F[5]-6B		4							
VPD30-6F[5]-4B[9]	30	2.5	64.4	41.3	20	18.5	6	7.0~12.6	
VPD30-6F[5]-6B[9]		4							
VPD30-10F[5]-4B		2.5	70.4	47.3		24.5	10	3.3~10.0	
VPD30-10F[5]-6B		4							
VPD30-15F[5]-4B		2.5	80.4	52.3	25	29.5	15	3.3~10.4	
VPD30-15F[5]-6B		4							
VPD30-20F[5]-4B		2.5	96.4	59.3	34	36.5	20	2.0~8.7	
VPD30-20F[5]-6B		4							

※ [5] : Replaced with Pad rubber material code. Refer to page 916 for details.

※ [9] : Replaced with "-S3" for -S3 spec. (Copper alloy free material for metal parts and FKM or HNBR for sealing parts). -S3 spec. is available for model codes with [9] in the table above.

※ Pad material N and NE are not suitable for use under ozone environment.

※ Tightening torque of a pad holder fixing bulkhead nut is as followings. Pad O.D. : ø10, ø15mm ▶ 8~10N·m. Pad O.D. : ø20~ø30mm ▶ 4.5~6N·m.

VPD Spring type / Side port / Female thread / Standard holder

PDF Compressor Free Version

RoHS Compliant Copper alloy free available CAD (2D&3D)

Stroke (mm)
6, 10, 15, 20

VPD10^[3]F^[5]-M6^[9]
VPD15^[3]F^[5]-M6^[9]

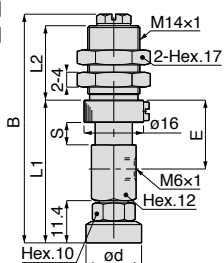

VPD20^[3]F^[5]-M6^[9]
VPD25^[3]F^[5]-M6^[9]
VPD30^[3]F^[5]-M6^[9]

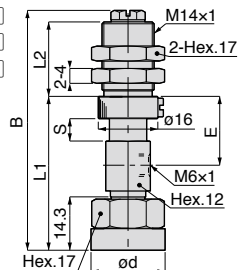

Unit : mm

Model code	Pad O.D. ød	B	L1	L2	E	Stroke S	Spring force (N)	Connection config. code
VPD10-6F ^[5] -M6 ^[9]	10	61.5	38.4	20	18.5	6	4.0~7.1	-M4
VPD10-10F ^[5] -M6		66.5	43.4		25	10	2.0~5.2	
VPD10-15F ^[5] -M6		76.5	48.4		25	30	2.0~5.9	
VPD10-20F ^[5] -M6		92.5	55.4		34	37	1.1~4.8	
VPD15-6F ^[5] -M6 ^[9]	15	61.5	38.4	20	18.5	6	4.0~7.1	-M4
VPD15-10F ^[5] -M6		66.5	43.4		25	10	2.0~5.2	
VPD15-15F ^[5] -M6		76.5	48.4		25	30	2.0~5.9	
VPD15-20F ^[5] -M6		92.5	55.4		34	37	1.1~4.8	
VPD20-6F ^[5] -M6 ^[9]	20	64.4	41.3	20	18.5	6	7.0~12.6	-M6
VPD20-10F ^[5] -M6		70.4	47.3		24.5	10	3.3~10.0	
VPD20-15F ^[5] -M6		80.4	52.3		25	29.5	3.3~10.4	
VPD20-20F ^[5] -M6		96.4	59.3		34	36.5	2.0~8.7	
VPD25-6F ^[5] -M6 ^[9]	25	64.4	41.3	20	18.5	6	4.0~7.1	-M6
VPD25-10F ^[5] -M6		70.4	47.3		24.5	10	2.0~5.2	
VPD25-15F ^[5] -M6		80.4	52.3		25	29.5	2.0~5.9	
VPD25-20F ^[5] -M6		96.4	59.3		34	36.5	1.1~4.8	
VPD30-6F ^[5] -M6 ^[9]	30	64.4	41.3	20	18.5	6	7.0~12.6	-M6
VPD30-10F ^[5] -M6		70.4	47.3		24.5	10	3.3~10.0	
VPD30-15F ^[5] -M6		80.4	52.3		25	29.5	3.3~10.4	
VPD30-20F ^[5] -M6		96.4	59.3		34	36.5	2.0~8.7	

※ [5] : Replaced with Pad rubber material code. Refer to page 916 for details.

※ [9] : Replaced with "-S3" for -S3 spec. (Copper alloy free material for metal parts and FKM or HNBR for sealing parts). -S3 spec. is available for model codes with [9] in the table above.

※ Pad material N and NE are not suitable for use under ozone environment.

※ Tightening torque of a pad holder fixing bulkhead nut is as followings. Pad O.D. : ø10, ø15mm ▶ 8~10N·m. Pad O.D. : ø20~ø30mm ▶ 4.5~6N·m.

VPOD Spring type / Side port / Push-in fitting / No cover holder

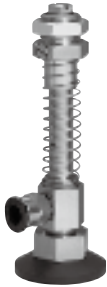

VPOD20 ³F ⁵ ⁶
VPOD25 ³F ⁵ ⁶
VPOD30 ³F ⁵ ⁶

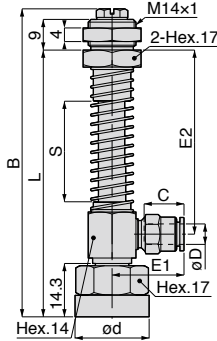

RoHS Compliant CAD (2D&3D)

Stroke (mm)
20,30,40,50

※ ⁵ : Replaced with Pad rubber material code. Refer to page 916 for details.
※ Tightening torque of a pad holder fixing bulkhead nut is 4.5~6N·m.

Unit : mm

Model code	Pad O.D. ød	Tube O.D. øD	B	L	E1	E2	Tube end C	Stroke S	Spring force (N)	Connection config. code		
VPOD20-20F ⁵ -3J	20	3	75.9	63.8	19.6	41	10.9	20	1.5~4.9	-M6		
VPOD20-20F ⁵ -4J		4					11.7					
VPOD20-20F ⁵ -6J		6			20.9							
VPOD20-30F ⁵ -3J		20	3	88.9	76.8	19.6	54	10.9	30		1.1~4.8	
VPOD20-30F ⁵ -4J			4					11.7				
VPOD20-30F ⁵ -6J			6			20.9						
VPOD20-40F ⁵ -3J			20	3	101.9	89.8	19.6	67	10.9		40	1.0~4.5
VPOD20-40F ⁵ -4J				4					11.7			
VPOD20-40F ⁵ -6J				6			20.9					
VPOD20-50F ⁵ -3J		20	3	114.9	102.8	19.6	80	10.9	50		0.9~4.5	
VPOD20-50F ⁵ -4J			4					11.7				
VPOD20-50F ⁵ -6J			6			20.9						
VPOD25-20F ⁵ -3J	25		3	75.9	63.8	19.6	41	10.9	20	1.5~4.9		
VPOD25-20F ⁵ -4J			4					11.7				
VPOD25-20F ⁵ -6J			6			20.9						
VPOD25-30F ⁵ -3J		25	3	88.9	76.8	19.6	54	10.9	30	1.1~4.8		
VPOD25-30F ⁵ -4J			4					11.7				
VPOD25-30F ⁵ -6J			6			20.9						
VPOD25-40F ⁵ -3J			25	3	101.9	89.8	19.6	67	10.9	40	1.0~4.5	
VPOD25-40F ⁵ -4J				4					11.7			
VPOD25-40F ⁵ -6J				6			20.9					
VPOD25-50F ⁵ -3J		25	3	114.9	102.8	19.6	80	10.9	50	0.9~4.5		
VPOD25-50F ⁵ -4J			4					11.7				
VPOD25-50F ⁵ -6J			6			20.9						
VPOD30-20F ⁵ -3J	30		3	75.9	63.8	19.6	41	10.9	20	1.5~4.9		
VPOD30-20F ⁵ -4J			4					11.7				
VPOD30-20F ⁵ -6J			6			20.9						
VPOD30-30F ⁵ -3J		30	3	88.9	76.8	19.6	54	10.9	30	1.1~4.8		
VPOD30-30F ⁵ -4J			4					11.7				
VPOD30-30F ⁵ -6J			6			20.9						
VPOD30-40F ⁵ -3J			30	3	101.9	89.8	19.6	67	10.9	40	1.0~4.5	
VPOD30-40F ⁵ -4J				4					11.7			
VPOD30-40F ⁵ -6J				6			20.9					
VPOD30-50F ⁵ -3J		30	3	114.9	102.8	19.6	80	10.9	50	0.9~4.5		
VPOD30-50F ⁵ -4J			4					11.7				
VPOD30-50F ⁵ -6J			6			20.9						

VPOD Spring type Side port Barb fitting / No cover holder



VPOD20 3 F 5 6
 VPOD25 3 F 5 6
 VPOD30 3 F 5 6

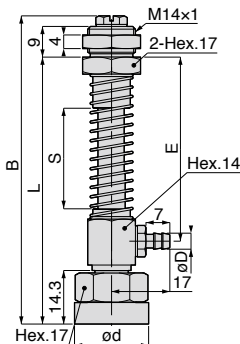

RoHS Compliant CAD (2D&3D)

Stroke (mm)
 20,30,40,50

Unit : mm

Model code	Pad O.D. ød	Tube I.D. øD	B	L	E	Stroke S	Spring force (N)	Connection config. code
VPOD20-20F5-4B	20	2.5	75.9	63.8	41	20	1.5~4.9	-M6
VPOD20-20F5-6B		4						
VPOD20-30F5-4B		2.5	88.9	76.8	54	30	1.1~4.8	
VPOD20-30F5-6B		4						
VPOD20-40F5-4B		2.5	101.9	89.8	67	40	1.0~4.5	
VPOD20-40F5-6B		4						
VPOD20-50F5-4B	2.5	114.9	102.8	80	50	0.9~4.5		
VPOD20-50F5-6B	4							
VPOD25-20F5-4B	25	2.5	75.9	63.8	41	20	1.5~4.9	
VPOD25-20F5-6B		4						
VPOD25-30F5-4B		2.5	88.9	76.8	54	30	1.1~4.8	
VPOD25-30F5-6B		4						
VPOD25-40F5-4B		2.5	101.9	89.8	67	40	1.0~4.5	
VPOD25-40F5-6B		4						
VPOD25-50F5-4B	2.5	114.9	102.8	80	50	0.9~4.5		
VPOD25-50F5-6B	4							
VPOD30-20F5-4B	30	2.5	75.9	63.8	41	20	1.5~4.9	
VPOD30-20F5-6B		4						
VPOD30-30F5-4B		2.5	88.9	76.8	54	30	1.1~4.8	
VPOD30-30F5-6B		4						
VPOD30-40F5-4B		2.5	101.9	89.8	67	40	1.0~4.5	
VPOD30-40F5-6B		4						
VPOD30-50F5-4B	2.5	114.9	102.8	80	50	0.9~4.5		
VPOD30-50F5-6B	4							

※ [5] : Replaced with Pad rubber material code. Refer to page 916 for details.

※ .Tightening torque of a pad holder fixing bulkhead nut is 4.5~6N·m.

VPOD **3F5** Spring type / Side port / Female thread / No cover holder



VPOD20**3F5**-M6
VPOD25**3F5**-M6
VPOD30**3F5**-M6

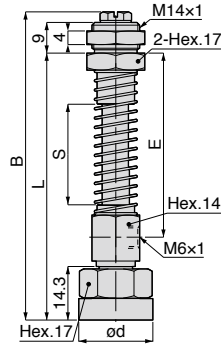

RoHS Compliant CAD (2D&3D)

Stroke (mm)
20,30,40,50

Unit : mm

Model code	Pad O.D. ød	B	L	E	Stroke S	Spring force (N)	Connection config. code
VPOD20-20F5-M6	20	75.9	63.8	41	20	1.5~4.9	-M6
VPOD20-30F5-M6		88.9	76.8	54	30	1.1~4.8	
VPOD20-40F5-M6		101.9	89.8	67	40	1.0~4.5	
VPOD20-50F5-M6		114.9	102.8	80	50	0.9~4.5	
VPOD25-20F5-M6	25	75.9	63.8	41	20	1.5~4.9	
VPOD25-30F5-M6		88.9	76.8	54	30	1.1~4.8	
VPOD25-40F5-M6		101.9	89.8	67	40	1.0~4.5	
VPOD25-50F5-M6		114.9	102.8	80	50	0.9~4.5	
VPOD30-20F5-M6	30	75.9	63.8	41	20	1.5~4.9	
VPOD30-30F5-M6		88.9	76.8	54	30	1.1~4.8	
VPOD30-40F5-M6		101.9	89.8	67	40	1.0~4.5	
VPOD30-50F5-M6		114.9	102.8	80	50	0.9~4.5	

※ [5] : Replaced with Pad rubber material code. Refer to page 916 for details.

※ . Tightening torque of a pad holder fixing bulkhead nut is 4.5~6N·m.

VPF **PDF Compressor Free Version** Spring type / Direct mount / Metric thread / Standard holder

RoHS Compliant Copper alloy free available CAD (2D&3D)



VPF10F [5][9]
VPF15F [5][9]

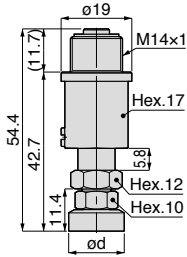

VPF20F [5][9]
VPF25F [5][9]
VPF30F [5][9]

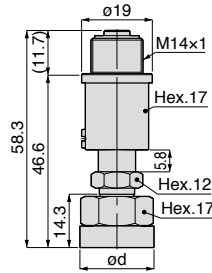

Stroke (mm)
5.8

Unit : mm

Model code	Pad O.D. ϕd	Spring force (N)	Connection config. code
VPF10F[5][9]	10	7.9 ~ 15.0	-M4
VPF15F[5][9]	15	7.9 ~ 15.0	
VPF20F[5][9]	20	7.9 ~ 15.0	
VPF25F[5][9]	25	7.9 ~ 15.0	-M6
VPF30F[5][9]	30	7.9 ~ 15.0	

- ※ [5] : Replaced with Pad rubber material code. Refer to page 916 for details.
- ※ [9] : Replaced with "-S3" for -S3 spec. (Copper alloy free material for metal parts and FKM or HNBR for sealing parts).
- ※ Pad material N and NE are not suitable for use under ozone environment.
- ※ Tightening torque of a pad holder fixing bulkhead nut is 4.5~6N·m.

■ Construction (Vacuum Pad Holder and Vacuum Pad Flat Series)

PDF Compressor Free Version

Pad dia. : $\phi 10, \phi 15\text{mm}$

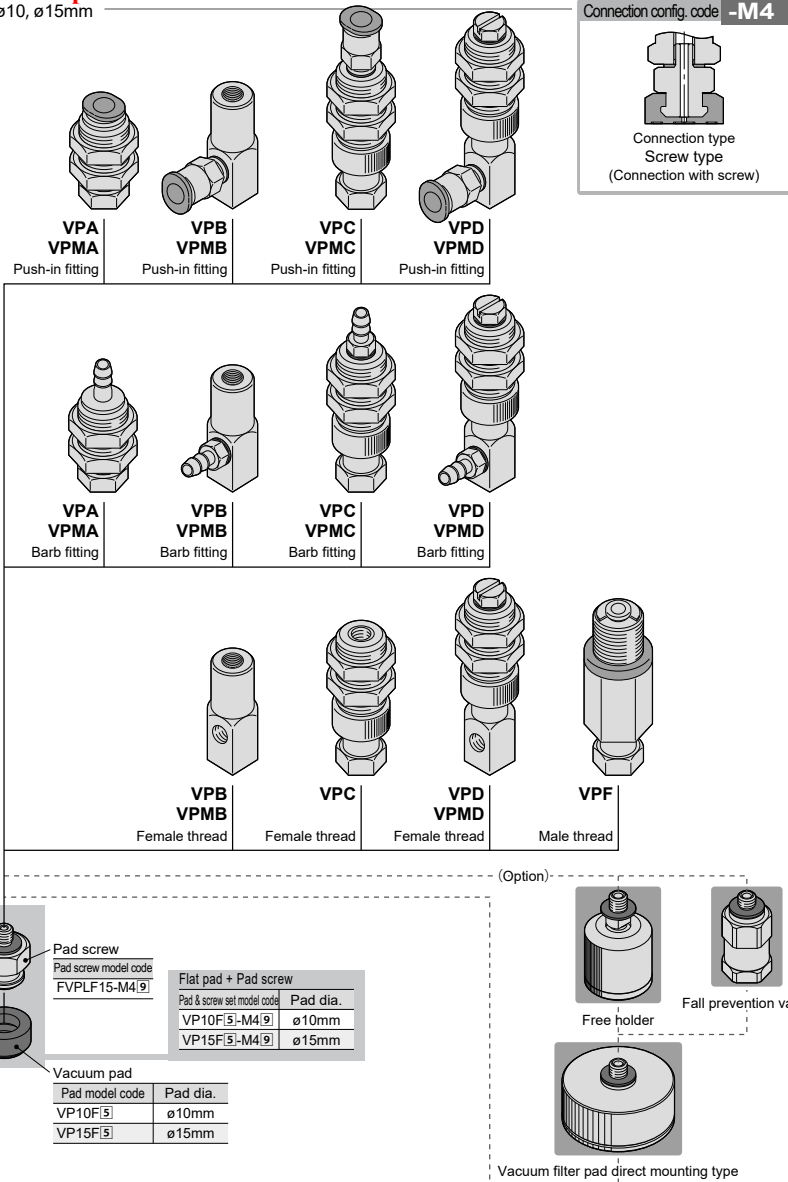

※ The Fitting model code for option "-S3" is different from that of standard products. Contact us for details.

※ Model code of Vacuum Pad Holder alone is following. Contact us for price.

■ Model designation (Example)

VP C -M4 -6 -4B -S3
[1] [3] [6] [9]

[1] : Holder type, [3] : Stroke(For spring type holder only. VPF holder is excluded.),
[6] : Port size · type, [9] : -S3 spec.

PDF Compressor Free Version

Pad dia. : $\varnothing 20$, $\varnothing 25$, $\varnothing 30$ mm

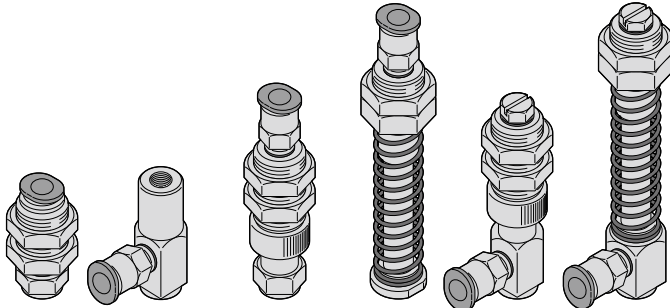

VPA VPMA Push-in fitting	VPB VPMB Push-in fitting	VPC VPMC Push-in fitting	VPOC Push-in fitting	VPD VPMD Push-in fitting	VPOD Push-in fitting
--	--	--	--------------------------------	--	--------------------------------

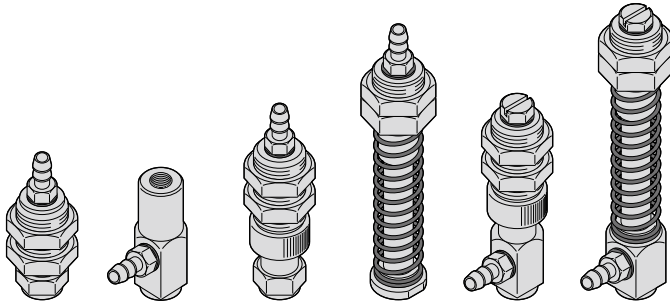

VPA VPMA Barb fitting	VPB VPMB Barb fitting	VPC VPMC Barb fitting	VPOC Barb fitting	VPD VPMD Barb fitting	VPOD Barb fitting
---	---	---	-----------------------------	---	-----------------------------

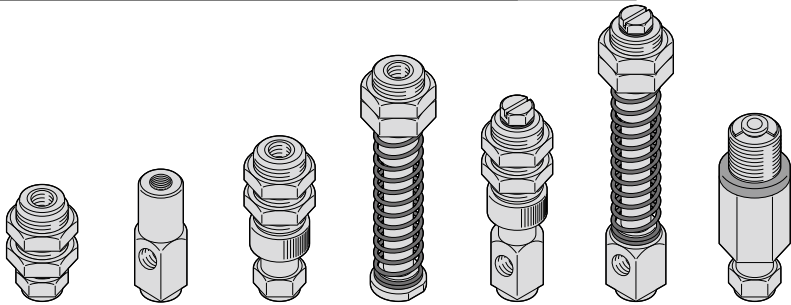

VPA Female thread	VPB VPMB Female thread	VPC Female thread	VPOC Female thread	VPD VPMD Female thread	VPOD Female thread	VPF Male thread
-----------------------------	--	-----------------------------	------------------------------	--	------------------------------	---------------------------

PDF Compressor Free Version

Connection config. code **-M6**

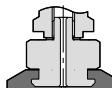

Connection type
 Screw type
 (Connection with screw)

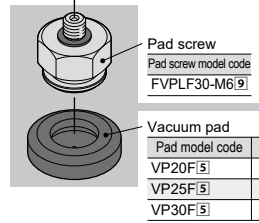
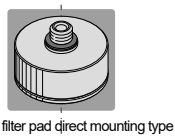
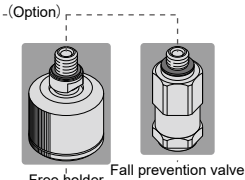

Flat pad + Pad screw	
Pad & screw set model code	Pad dia.
VP20F[5]-M6[9]	ø20mm
VP25F[5]-M6[9]	ø25mm
VP30F[5]-M6[9]	ø30mm

※ The Fitting model code for option "-S3" is different from that of standard products. Contact us for details.
 ※ Model code of Vacuum Pad Holder alone is following. Contact us for price.

■ Model designation (Example)

VP C -M6 -6 -6B -S3
 [1] [3] [6] [9]

[1] : Holder type, [3]:Stroke(For spring type holder only. VPF holder is excluded.), [6] : Port size · type, [9] : -S3 spec.



PDF Compressor Free Version



Common Safety Instructions for Vacuum Pads

PDF Compressor Free Version

Before selecting or using PISCO products, read the following instructions. Read the detailed instructions for individual series.

⚠ Warning

1. Take safety measures in advance where a dropping work-piece can cause danger.
2. Make sure to install a vacuum pad holder securely. Looseness may cause trouble.
3. Pay special attention to the work conveyance by screwed vacuum pads, accompanied by rotary movement. There is a possibility of troubles due to the looseness of screws from the rotary movement.
4. There is a possibility of troubles due to the leakage of vacuum system, clogging, vacuum pad abrasion, crack, deterioration, the galling of slider part in the holder and the looseness in joints. Carry out maintenance inspection periodically.
5. When a work-piece is conveyed by a vacuum pad, consider the acceleration, impacts and wind pressure. Otherwise, the work-piece may drop during conveyance.

⚠ Caution

1. Thoroughly read and understand the theoretical suction force in this catalog before selecting diameter, Qty and suction place of vacuum pads. Select vacuum pads with enough margin in suction force.
2. The product incorporating NBR as seal rubber material has a risk of malfunction caused by ozone crack. Ozone exists in high concentrations in static elimination air, clean-room, and near the high-voltage motors, etc. As a countermeasure, material change from NBR to HNBR or FKM is necessary. Consult with Pisco for more information.
3. Select the material of vacuum pad in accordance with use environment and ease of use, referring to "Selecting Method".
4. Select the suitable pad shape (type) in accordance with a work-piece and its shape, referring to "Characteristics of Pad Material".
5. Select spring-holder type when work-pieces have different heights or are weak against an external force. Select the suitable holder type, referring to spring force and spring length in the catalog.
6. Since spring-holder type has a sliding action, minimize the transverse load. Otherwise, the life time of the holder can be reduced or malfunction of the holder can occur.
7. In replacing vacuum pads, check the structure of holders and pads in the catalog and tighten the hexagonal-column of the holder with a proper tool, referring to the following tightening torque.

● Table. tightening torque

Vacuum pad holder	Standard	Mini
Pad screw size (mm)	Tightening torque (N·m)	
M4×0.7	0.5 ~ 1.0	0.9 ~ 1.1
M6×1	2 ~ 2.7	
M10×1.5	5 ~ 7	—
M20×2	9 ~ 10	—

8. In replacing the adapters of Soft / Soft Bellows Series, check the structure of holders, pad and adapters and tighten the hexagonal-column of the holder with a proper tool, referring to the following tightening torque.

● Table. tightening torque

Pad screw size (mm)	Tightening torque (N·m)
M4×0.7	0.7 ~ 0.8
M6×1	1.5 ~ 2.0

PDF Compressor Free Version

9. In installing vacuum pad holders of general and small type with bulkhead, check the structure and tighten the hexagonal-column of the holder with a proper tool, referring to the following tightening torque.

Vacuum pad holder	Standard			Mini		
Vacuum pad holder type	VPA	VPC, VPD, VPF, VPHC, VPHD, VPHDW	VPE	VPMA	VPMC, VPMD	VPME
Bulkhead nut size (mm)	Tightening torque (N·m)					
M3×0.5	—	—	0.7	—	—	0.7
M4×0.5	—	—	—	1 ~ 1.2	—	—
M4×0.7	1 ~ 1.2	—	—	—	—	—
M5×0.5	1.5 ~ 2	—	—	1.5 ~ 2	—	—
M5×0.8	—	—	1 ~ 1.5	—	—	1 ~ 1.5
M6×0.75	2 ~ 3	—	—	2 ~ 3		—
M8×0.75	2.5 ~ 3.5	1.8 ~ 2.4	—	2.5 ~ 3.5		—
M8×1	—	1.8 ~ 2.4	—	—	—	—
M10×1	5 ~ 7	4.5 ~ 6	—	5 ~ 7	4 ~ 6	—
M12×1	12 ~ 14	8 ~ 10	—	—	—	—
M14×1	18 ~ 21	4.5 ~ 6	—	—	—	—
M16×1	18 ~ 21 (※)	2 ~ 3	—	—	—	—
M20×1	19 ~ 21	—	—	—	—	—
M22×1	19 ~ 21 (※)	16 ~ 20	—	—	—	—
M24×2	40 ~ 50	—	—	—	—	—
M30×2	—	42 ~ 54	—	—	—	—

※Values for Vacuum pad holder for Packaging bag series.

10. In replacing vacuum pad rubbers of Standard Series $\phi 80$, $\phi 100$ mm, $\phi 150$ mm, $\phi 200$ mm and Bellows Series $\phi 80$ mm, $\phi 100$ mm, check the structure of holders and pads and tighten the hexagonal-column of the holder with a proper tool, referring to the following tightening torque.

● Table. tightening torque

Pad screw size (mm)	Tightening torque (N·m)
M4×0.7	0.5 ~ 0.7
M5×0.8	

11. Check the structure of vacuum pad in the catalog before replacing a filter element.
 12. Refer to "Common Safety Instructions for Fittings" for handling fitting joint parts.
 13. In installing spring-holder type, do not hold the shaft (A) with a spanner.
 In replacing vacuum pad, hold the hexagonal-column of the shaft with a spanner. If the keyway (B) is deformed, there is a possibility of malfunction.
 14. Excessive tightening of a fixing nut may deform the bulkhead part and result in malfunction of the keyway.
 15. As the nature of rubber, powdery component like additives may come out on the surface of a vacuum pad as time elapses.

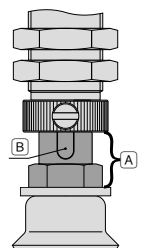

Vacuum Pad Selection Guide

PDF Compressor Free Version

Selection Guide 1 ▶ Select the diameter of vacuum pad from the formula ① and chart of the theoretical suction force ②

The theoretical suction force is determined from pad area and vacuum level. Calculated value is for reference only, so carry out the evaluation under an actual operating condition. The theoretical suction force is calculated under a static condition. Obtain an enough margin, considering the weight of a work-piece and acceleration of lifting, pause and rotary movement. Enough room is needed in deciding a number of pads and arrangement position.

① Calculation by formula

$$W = \frac{C \times P}{101} \times 10.13 \times f$$

- W : Suction force(N)
- C : Pad area(cm²)
- P : Vacuum level -kPa
- f : Safety factor Horizontal lifting (refer to the right fig.) ▶ 1/4
Vertical lifting (refer to the right fig.) ▶ 1/8

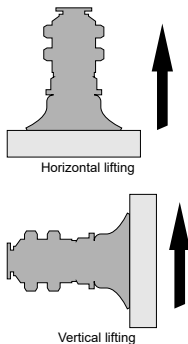

- *1.Refer to the following chart for Sponge Series.(Internal diameter is used for calculation)
- *2.Refer to the following chart for Flat Series.(Pad grooves are used for calculation)
- *3.As for Bellows, Multi-Bellows, Soft, Soft Bellows and Ultrathin Series, their theoretical suction force may exceed the strength of pad itself, depending on the vacuum level. Carry out the evaluation under an actual operating condition.

② Chart of the theoretical suction force <Add safety factor to values from the chart>

Standard / Bellows / Multi-bellows / Soft / Soft bellows / Skidproof / Ultrathin / Mark-free (*)

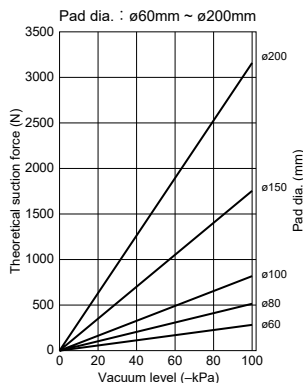
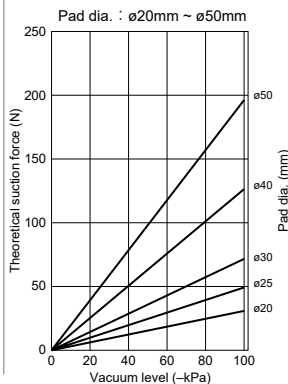
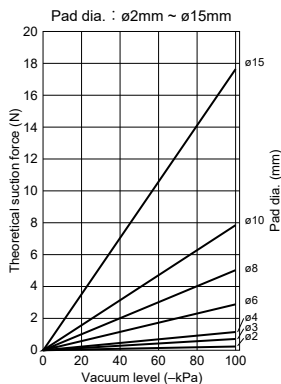
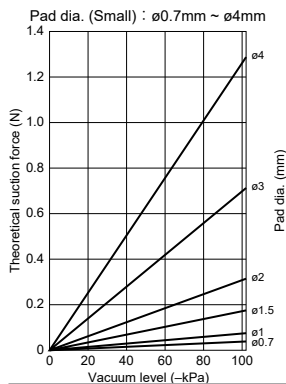

*Some sizes are not available for some pad series. Refer to the following size list.

● : indicates that pad size is available

Pad type	Standard	Bellows	Multi-bellows	Soft	Soft bellows	Skidproof	Ultra thin	Mark-free
ø0.7~ø3	●	—	—	—	—	—	—	—
ø4	●	—	—	●	—	—	—	—
ø6	●	●	—	●	●	—	—	—
ø8	●	●	—	●	●	—	●	—
ø10	●	●	●	●	●	●	—	●
ø15	●	●	●	●	●	—	●	—
ø20	●	●	●	●	●	●	●	●
ø25	●	●	—	—	—	—	—	—
ø30	●	●	●	●	—	—	—	●
ø40	●	●	●	—	—	—	●	—
ø50	●	●	●	—	—	●	—	—
ø60	●	●	—	—	—	—	—	—
ø80	●	●	—	—	—	—	—	—
ø100	●	●	—	—	—	—	—	—
ø150	●	—	—	—	—	—	—	—
ø200	●	—	—	—	—	—	—	—

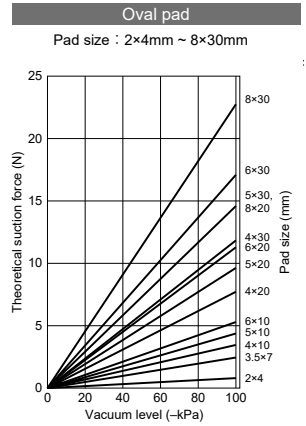
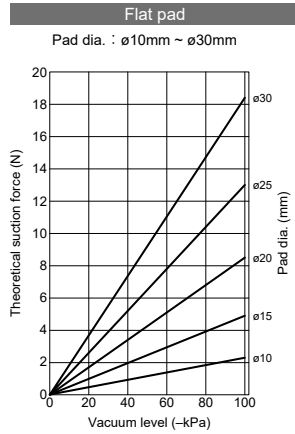
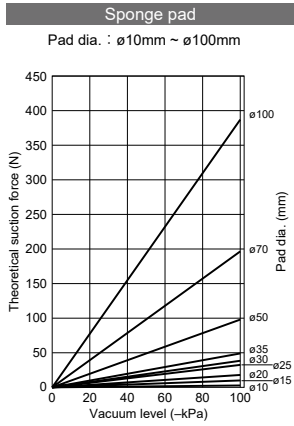

PDF Compressor Free Version



PDF Compressor Free Version

Selection Guide 2 ▶ Select a vacuum pad type according to a work-piece.

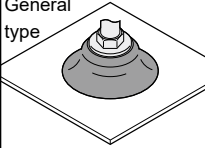
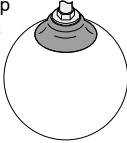
Please select suitable pads for your application from the following.

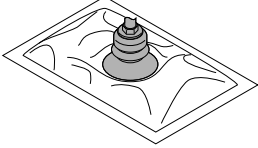
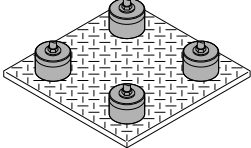
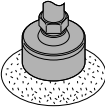
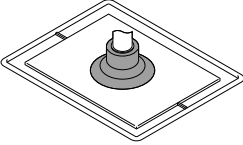
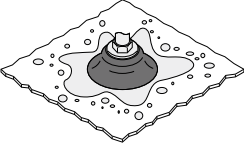
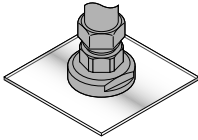
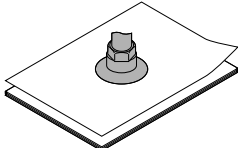
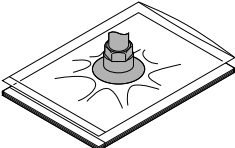
Standard Series			Bellows / Multi-bellows Series
General type 	Deep type 	Small type 	
Thick & flat work-piece	Round fruit or ball (*1)	Small work-piece or semiconductor manufacturing device	Food package
Sponge Series		Oval Series	
			
Exterior wall panel, pebble, seashell		Long work-piece (e.g. circuit board and semiconductor product)	
Soft / Soft bellows Series	Skidproof Series	Mark-free Series	
			
Taking out molded parts / Fragile work-piece	Greasy work-piece such as pressed parts	LCD glass / in Painting process / semiconductor manufacturing device	
Ultrathin Series		Flat Series	
			
Thin work-piece such as paper or plastic bag		Thin work-piece such as sheet or plastic bag	

*1.The table below is a reference for the vacuum pad deep type and the size of round work-piece.

Spherical dia. : S (mm)	ø20	ø30	ø40	ø50	ø80	ø100	ø120	ø160	ø200
Pad size : d (mm)	ø15	ø20	ø25	ø30	ø40	ø50	ø60	ø80	ø100

*2.Refer to the previous page for pad dia. selection except deep type. Refer to the next page for the characteristics of pad materials.

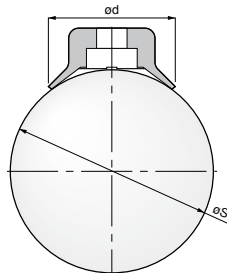

PDF Compressor Free Version

Selection Guide 2 ▶ Select a vacuum pad material from an application..

Please select the suitable material from the table.

Item	Pad material	Nitrile rubber	NBR Suited for the food sanitation act. (Japan)	HNBR	Silicone rubber	Conductive Silicone rubber	Urethane rubber	Fluoro rubber	Fluorosilicone rubber	EPDM	Conductive Butadiene rubber (Low resistance type)	Conductive NBR (low resistance)	Chloroprene rubber (For Sponge type)	Silicone rubber (For Sponge Type)		
	Material code	N, NH (*1)	G	HN	S	SE	U	F	FS	EP	E	NE	-	S		
Application		Cardboard Plywood Metal plate Food-related Other general work	Cardboard Plywood Metal plate Food-related Other general work In use under a low ozone concentration environment.	Semiconductors Taking out molded parts Thin work-piece Food-related	Cardboard Plywood Metal plate	Chemical environment High temp. work-pieces	Taking out molded parts	Application that requires light-resistant or ozoneproof In use under the moisture containing atmosphere	General pars of semiconductors	Semi-conductors	Uneven work-piece	Uneven work-piece Food-related				
Pad color		Black	Gray	Black	Translucent	Black	Blue	Gray	Salmon	Black	Black	Black	Black	Salmon		
Physical Properties	Surface hardness (Shore A)	Standard	50°~80°	60°~70°	50°~70°	50°	60°	55°~70°	60°~70°	-	50°~70°	70°	60°~70°	-	-	
		Bellows	50°	-	50°	50°	60°	55°	60°	-	50°	-	60°	-	-	
		Multi-bellows	50°	50°	50°	50°	50°	-	55°	50°	-	50°	-	60°	-	-
		Oval	40°~50°	-	50°	40°~50°	50°~60°	55° (*2)	50° (*2)	-	50°	70°	70°	-	-	
		Soft	40°	-	-	40°	60°	-	-	40°	-	-	50°	-	-	
		Soft bellows	40°	-	50°	40°	-	55°	-	-	50°	-	60°	-	-	
		Skidproof	50°	-	-	50°	-	55°	60°	-	-	-	60°	-	-	
		Ultrathin	40°	-	-	40°	-	55°	50°	40°	-	-	60°	-	-	
	Flat	60°	-	-	40°	40°	50°	50°	-	-	-	60°	-	-		
	Highest operating temp.		110°C	140°C	180°C	60°C	230°C	180°C	150°C	100°C	110°C	80°C	180°C			
	Lowest operating temp.		-30°C	-30°C	-40°C	-20°C	-10°C	-50°C	-40°C	-50°C	-30°C	-45°C	-40°C			
	Weatherability		△	○	◎	○	◎	◎	◎	◎	△	○	◎			
	Ozone-proof		×	○	◎	◎	◎	◎	◎	◎	×	×	○	◎		
	Acid-resistance		△	△	○	×	◎	○	◎	△	△	△	○			
Alkaline-resistance		○	○	◎	×	◎	◎	◎	○	○	◎	◎				
Oil resistance	(Gasoline oil)	◎	◎	△	◎	◎	△	△	×	×	◎	×	△			
	(Benzene/toluene)	△	×	△	△	◎	△	△	×	×	△	△	△			
Volume resistance		-	-	-	Max. 10 ¹⁰ Ω·cm	-	-	-	-	-	Max. 2000Ω·cm	Max. 2000Ω·cm	-	-		

Legend ⇄
 ◎ : Best
 ○ : Suitable
 △ : Good
 × : NG

*1. Material code "NH" is only available for Skidproof Series.

*2. It does not apply to pad size: 4×30mm.

Note 1). The above "Physical Properties" shows the data of general synthetic rubbers.

Note 2). The highest / lowest operating temp. is for momentary usage. Carry out durability evaluation in case of continuous usage under the highest / lowest operating temp.

Vacuum pad

PDF Compressor Free Version

Please select the suitable vacuum pad resin material from the table.

Item	Pad material		PEEK	POM	Conductive PEEK
	Material code	Mark free series Resin attachment for Bellows series	K -QK	M -QM	KE -QKE
Application			Manufacturing machine for liquid crystal / semiconductor	General production line Food-related machine Packaging machine	Manufacturing machine for liquid crystal / semiconductor Electronic components
Pad color			Natural (ivory)	White	Black
Physical Properties	Highest operating temp.		250°C	95°C	250°C
	Lowest operating temp.		-50°C	-60°C	-50°C
	Weatherability		◎	×	◎
	Acid-resistance		◎	×	◎
	Alkaline-resistance		◎	△	◎
	Self-lubricity		○	◎	○
	Abrasion-resistance		◎	◎	◎
Volume resistance		-		10 ⁸ ~10 ⁹ Ω·cm	

- Legend
- ◎ : Best
 - : Suitable
 - △ : Good
 - ×
 - NG

- Note 1).The above "Physical Properties" shows the data of pad resin material only. The holder of Mark-free Series is not included.
 Note 2).The above "Physical Properties" shows the data of resin attachment only. The pad rubber is not included.
 Note 3).The above "Physical Properties" shows a general properties of resin materials and not a guaranteed value. Carry out the necessary evaluation under an actual operating condition.
 Note 4).The highest / lowest operating temp. is for momentary usage. Carry out durability evaluation in case of continuous usage under the highest / lowest operating temp.
 Note 5).Volume resistance is a representative value from the material manufacture, and not a guaranteed value.

To prevent dust from getting into the pad holder.

Install a vacuum filter pad direct mounting type between a vacuum pad and a holder.

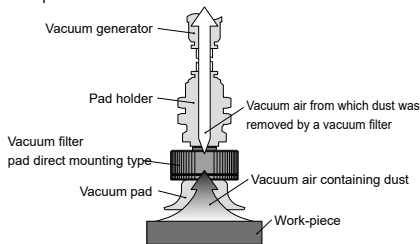

To prevent dust from getting into the pad holder.

Installing a fall prevention valve between a vacuum pad and a holder prevents the troubles like system break down, minimizing the vacuum drop of the whole system automatically by reducing suction flow of the part where the work-piece falls from the vacuum pad (within the range not causing any problem), or no work-piece is to be sucked.

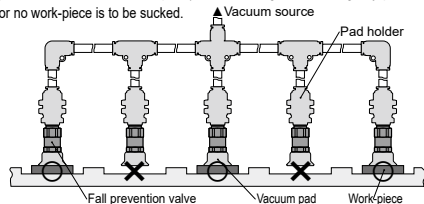

Reference Guide for Vacuum Pad

PDF Compressor Free Version

Impact on pad

Avoid an impact or a large force on a vacuum pad, when it is pressed against a work-piece. It may cause deformation, crack or abrasion at an early stage of use. Adjust the pad position so that the lip of pad touches lightly on a work-piece. Especially a small type of vacuum pad should be positioned precisely.

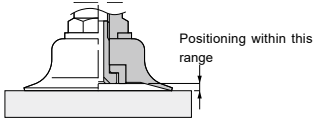

Porous or perforated work-piece

Since the suction of a porous work-piece causes a drop of suction force, select the proper specifications of vacuum system and secure a larger effective crosssection area of the piping. Selecting a small type of vacuum pad is one of solutions to reduce the air leakage.

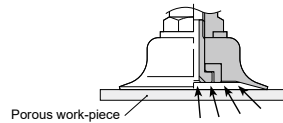

Large and wide flat plate work-piece

When lifting large size of glass board or circuit board, work-piece may bend by the lifting acceleration or the self-weight. Select a proper size of pad and positioning, considering an enough margin of suction force.

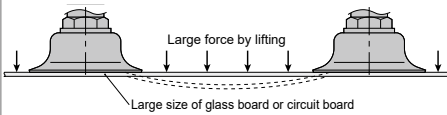

Lifting work-piece, sucking the both side of it

Since all vacuum pad holders are designed for horizontal lifting, consider the strength of holders and pads.

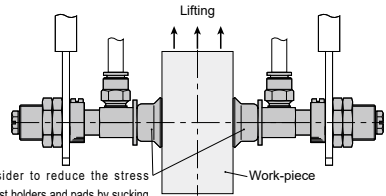

Soft work-piece

When soft work-pieces such as plastic bags, papers or thin boards are sucked, work-pieces can be deformed or shrunk by vacuum suction (Figure-1). Select smaller vacuum pads and reduce the vacuum pressure. Smaller vacuum pads are suitable for plastic bags and papers. When plastic / paper bags are opened by using vacuum pads, shift the center of two vacuum pads slightly in order to open them easily as Figure-2 shows.

•Figure-1

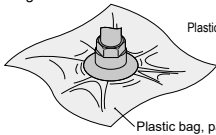

•Figure-2

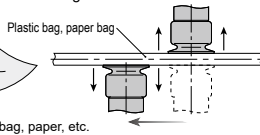

Work-piece with different heights

Select Long Stroke holders for work-pieces having different heights, or piled-up work-pieces. Its stroke can absorb the difference in height.

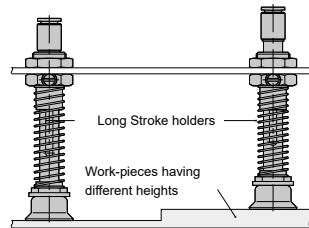

Inclined work-piece

Select Free Holder for an inclined work-piece.

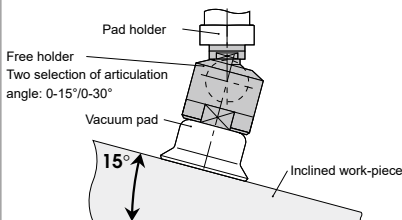

Conveyance with rotary movement

When vacuum pad is fixed with a screw and has a rotary movement, the pad may drop due to the loosened screw. Pay special attention when the vacuum location of work-piece is off the center of work-piece gravity.

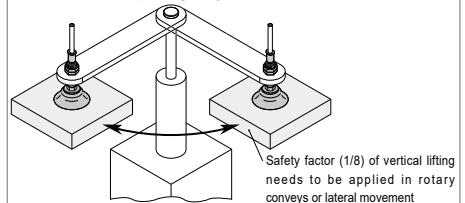



Pad dia. list by pad type and material

Pad material		PDF Compressor Free Version N : Nitrile rubber									
Pad type	Standard			Bellows	Multi-Bellows	Soft	Soft bellows	Ultrathin	Flat		
	General type	Deep type	Small type								
Pad dia. (mm)	ø0.7			●							
	ø1	●		●							
	ø1.5			●							
	ø2	●		●							
	ø3	●		●							
	ø4	●		●			●				
	ø6	●			●		●	●			
	ø8	●			●		●	●	●		
	ø10	●			●	●	●	●	●	●	●
	ø15	●	●		●		●	●	●	●	●
	ø20	●	●		●	●	●	●	●	●	●
	ø25	●	●		●						●
	ø30	●	●		●	●	●				●
	ø40	●	●		●	●	●				
	ø50	●	●		●	●					
	ø60	●	●		●						
	ø80	●	●		●						
	ø100	●	●		●						
	ø150	●									
ø200	●										

● : Available

Pad material		S : Silicone rubber									
Pad type	Standard			Bellows	Multi-Bellows	Soft	Soft bellows	Flat	Skidproof	Ultrathin	Sponge
	General type	Deep type	Small type								
Pad dia. (mm)	ø0.7			●							
	ø1	●		●							
	ø1.5			●							
	ø2	●		●							
	ø3	●		●							
	ø4	●		●			●				
	ø6	●			●		●	●			
	ø8	●			●		●	●		●	
	ø10	●			●	●	●	●	●	●	●
	ø15	●	●		●		●	●	●	●	●
	ø20	●	●		●	●	●	●	●	●	●
	ø25	●	●		●				●		●
	ø30	●	●		●	●	●		●	●	●
	ø35										●
	ø40	●	●		●	●	●		●		●
	ø50	●	●		●	●			●		●
	ø60	●	●		●				●		●
	ø70										●
	ø80	●	●		●						
ø100	●	●		●						●	
ø150	●										
ø200	●										

● : Available

Pad material		F : Fluoro rubber			U : Urethane rubber					
Pad type	Standard			Bellows	Multi-Bellows	Soft bellows	Skidproof	Ultrathin	Flat	
	General type	Deep type	Small type							
Pad dia. (mm)	ø0.7			●						
	ø1	●		●						
	ø1.5			●						
	ø2	●		●						
	ø3	●		●						
	ø4	●		●						
	ø6	●			●		●			
	ø8	●			●		●		●	
	ø10	●			●	●	●	●	●	●
	ø15	●	●		●		●		●	●
	ø20	●	●		●	●	●	●	●	●
	ø25	●	●		●					●
	ø30	●	●		●	●				●
	ø40	●	●		●	●		●		
	ø50	●	●		●	●		●		
	ø60	●	●		●					
	ø80	●	●		●					
	ø100	●	●		●					
ø150	●									
ø200	●									

● : Available

Pad material		F : Fluoro rubber						G : NBR Suited for the food sanitation act. (Japan)					
Pad type	Standard			Bellows	Multi-Bellows	Skidproof	Ultrathin	Flat	Standard			Multi-Bellows	
	General type	Deep type	Small type						General type	Deep type	Small type		
Pad dia. (mm)	ø0.7			●								●	
	ø1	●		●					●			●	
	ø1.5			●								●	
	ø2	●		●					●			●	
	ø3	●		●					●			●	
	ø4	●		●					●			●	
	ø6	●			●				●				
	ø8	●			●			●	●				
	ø10	●			●	●	●	●	●				●
	ø15	●	●		●		●	●	●	●	●		
	ø20	●	●		●	●	●	●	●	●	●		●
	ø25	●	●		●				●	●	●		
	ø30	●	●		●	●	●		●	●	●		●
	ø40	●	●		●	●	●		●	●	●		●
	ø50	●	●		●	●	●			●	●		●
	ø60	●	●		●								
	ø80	●	●		●								
	ø100	●	●		●								
ø150	●												
ø200	●												

● : Available



Vacuum Pad

PDF Compressor Free Version

Pad material		SE : Conductive Silicone rubber				E : Conductive Butadiene rubber (Low resistance type)		S : Chloroprene rubber	NH : Oilproof NBR
Pad type	Standard		Bellows	Soft	Flat	Standard		Sponge	Skidproof
	General type	Small type				General type	Small type		
Pad dia. (mm)	ø0.7		●				●		
	ø1	●	●				●		
	ø1.5		●				●		
	ø2	●	●				●		
	ø3	●	●				●		
	ø4	●	●		●		●		
	ø6	●		●	●		●		
	ø8	●		●	●		●		
	ø10	●		●	●	●	●	●	●
	ø15	●		●	●	●	●	●	
	ø20	●		●	●	●	●	●	●
	ø25	●		●	●	●	●	●	
	ø30	●		●	●	●	●	●	●
	ø35							●	
	ø40	●		●	●		●		●
	ø50	●		●			●	●	●
	ø60	●		●					
	ø70							●	
	ø80	●		●					
	ø100	●		●				●	
ø150	●								
ø200	●								

● : Available

487

Pad material		NE : Conductive NBR (low resistance)								
Pad type	Standard			Bellows type	Multi-Bellows	Soft	Soft bellows	Skidproof	Ultrathin	Flat
	General type	Deep type	Small type							
Pad dia. (mm)	ø0.7			●						
	ø1	●		●						
	ø1.5			●						
	ø2	●		●						
	ø3	●		●						
	ø4	●		●			●			
	ø6	●			●		●	●		
	ø8	●			●		●	●	●	
	ø10	●			●	●	●	●	●	●
	ø15	●	●		●	●	●	●	●	●
	ø20	●	●		●	●	●	●	●	●
	ø25	●	●		●					●
	ø30	●	●		●	●	●		●	●
	ø40	●	●		●	●	●		●	
	ø50	●	●		●	●			●	
	ø60	●	●		●					
	ø80	●			●					
	ø100	●	●		●					
	ø150	●								
	ø200	●								

● : Available

Vacuum Pad

Pad material		HNBR					EP : EPDM					FS : Fluorosilicone rubber	
Pad type	Standard			Bellows	Multi-Bellows	Soft bellows	Standard		Bellows type	Multi-Bellows	Soft bellows	Soft	Ultrathin
	General type	Deep type	Small type				General type	Deep type					
Pad dia. (mm)	ø0.7			●					●				
	ø1	●		●			●		●				
	ø1.5			●					●				
	ø2	●		●			●		●				
	ø3	●		●			●		●				
	ø4	●		●			●		●				
	ø6	●			●		●		●		●	●	
	ø8	●			●		●		●		●	●	●
	ø10	●			●	●	●		●	●	●	●	●
	ø15	●	●		●		●	●	●	●	●	●	●
	ø20	●	●		●	●	●	●	●	●	●	●	●
	ø25	●	●		●		●	●	●				
	ø30	●	●		●	●	●	●	●	●		●	
	ø40	●	●		●	●	●	●	●	●		●	
	ø50	●	●		●	●	●	●	●	●			
ø60	●	●		●		●	●	●					
ø80	●	●		●		●	●	●					
ø100	●	●		●		●	●	●					
ø150	●					●							
ø200	●					●							

● : Available

Pad material	N Nitrile rubber	S Silicone rubber	U Urethane rubber	F Fluoro rubber	SE Conductive Silicone rubber	E Conductive Butadiene rubber (Low resistance type)	NE Conductive NBR (Low resistance type)	HN HNBR	EP EPDM
Pad type	Oval								
Pad dia. (mm)	2×4	●	●	●	●		●	●	●
	3.5×7	●	●	●	●		●	●	●
	4×10	●	●	●	●		●	●	●
	4×20	●	●	●	●		●	●	●
	4×30	●	●				●	●	●
	5×10	●	●	●	●		●	●	●
	5×20	●	●	●	●		●	●	●
	5×30	●	●	●	●		●	●	●
	6×10	●	●	●	●		●	●	●
	6×20	●	●	●	●		●	●	●
	6×30	●	●	●	●		●	●	●
8×20	●	●	●	●		●	●	●	
8×30	●	●	●	●		●	●	●	

● : Available

Pad material	K : PEEK	M : POM	KE : Conductive PEEK	Q2K : PEEK	Q2M : POM	Q2KE : Conductive PEEK
Pad type	Mark free		Resin attachment for Bellows series			
Pad dia. (mm)	ø10	●	●	●	●	●
	ø15				●	●
	ø20	●	●	●	●	●
	ø25				●	●
	ø30	●	●	●	●	●

● : Available

Construction (VPA holder : Fixed type / Top port)

PDF Compressor Free Version

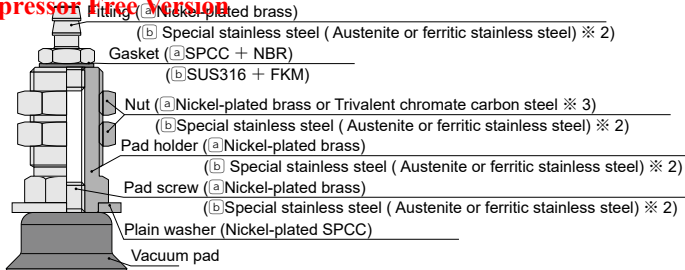

Construction (VPC holder : Spring type / Top port)

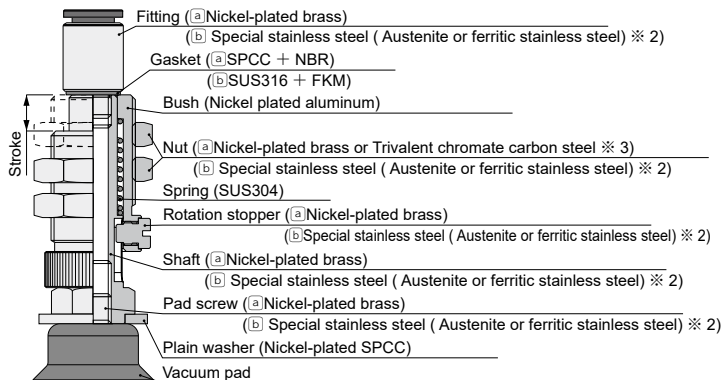

※ 1. (a) : Standard spec. (b) : "-S3" spec.

※ 2. SUS303 equivalent corrosivity

※ 3. Nut material differs depending on the bulkhead thread size. See below table for details.

Bulkhead thread size (mm)	Nut material	
	Nickel-plated brass	Trivalent chromate carbon steel
M5×0.5	○	—
M6×0.75	○	—
M8×0.75	○	—
M10×1	○	—
M12×1	—	○
M14×1	—	○
M16×1	—	○
M20×1	—	○
M22×1	—	○
M24×2	○	—
M30×2	○	—



Safety Instructions

PDF Compressor Free Version

This safety instructions aims to prevent personal injury and damage to properties by requiring proper use of PISCO products.

Be certain to follow ISO 4414 and JIS B 8370.

ISO 4414 : Pneumatic fluid power...General rules and safety requirements for system and their components.

JIS B 8370 : General rules and safety requirements for systems and their components.

This safety instructions is classified into "Danger", "Warning" and "Caution" depending on the degree of danger or damages caused by improper use of PISCO products.



Danger

Hazardous conditions. It can cause death or serious personal injury.



Warning

Hazardous conditions depending on usages. Improper use of PISCO products can cause death or serious personal injury.



Caution

Hazardous conditions depending on usages. Improper use of PISCO products can cause personal injury or damages to properties.



Danger

1. Do not use PISCO products for the following applications.

- ①. Equipment used for maintaining / handling human life and body.
- ②. Equipment used for moving / transporting human.
- ③. Equipment specifically used for safety purposes.



Warning

1. Selection of pneumatic products

- ①. A user who is a pneumatic system designer or has sufficient experience and technical expertise should select pneumatic equipments.
- ②. Due to wide variety of operating conditions and applications for PISCO products, carry out the analysis and evaluation on PISCO products. The pneumatic system designer is solely responsible for assuring that the user's requirements are met and that the application presents no health or safety hazards. All designers are required to fully understand the specifications of PISCO products and constitute all systems based on the latest catalog or information, considering any malfunctions.

2. Usage environment

Do not use PISCO products under the following conditions.

- ①. Beyond the specifications or conditions stated in the catalog, or the instructions.
- ②. Use at outdoors
- ③. Excessive vibrations and impacts.
- ④. Exposure / adhere to corrosive gas, flammable gas, chemicals, seawater, water and vapor.

PDF Compressor Free Version

3. Handling of product

- ①. Handle the pneumatic equipment with enough knowledge and experience.
Mishandling of compressed air is dangerous. A person having enough knowledge and experiences should carry out assembly, operation, and maintenance of devices equipped with pneumatic equipments.
- ②. Do not operate machine / equipment or remove pneumatic equipment until safety is confirmed.
 - (1). Make sure that preventive measures against falling work-pieces or sudden movements of machine are completed before inspection or maintenance of these machine.
 - (2). Make sure the above preventive measures are completed. A compressed air supply and the power supply to the machine must be off, and also the compressed air in the systems must be exhausted.
 - (3). Restart the machines with care after ensuring to take all preventive measures against sudden movements.
- ③. Do not disassemble or modify PISCO products, which affect the performance, function, and basic structure of the product.
- ④. Take safety measures such as providing a protection cover if there is a risk of causing damages or fire on machine / facilities by a fluid leakage.
- ⑤. Do not touch the release-ring of a push-in fitting when there is a working pressure. The lock may be released by the physical contact, and tube may fly out or slip out.
- ⑥. Frequent switchover of compressed air may generate heat, and there is a risk of causing burn injury.
- ⑦. Avoid any load on PISCO products, such as, a tensile strength, twisting and bending. Otherwise, there is a risk of causing damage to the products.
- ⑧. Do not use PISCO products for applications where threads or tubes swing / rotate. The product can be damaged in these applications.
- ⑨. Do not swing or rotate resin body of the products by force. It may damage to the products and cause a fluid leakage.
- ⑩. Do not supply excessively dry air to products. It may cause malfunction due to a deterioration of rubber parts.
- ⑪. Do not wash or paint products with water or solvent. Solvent may damage a resin body, or painting may cause malfunction.
- ⑫. The product incorporating NBR as seal rubber or gasket material has a risk of malfunction caused by ozone crack. Ozone exists in high concentrations in static elimination air, clean-room, and near the high-voltage motors, etc. As a countermeasure, material change from NBR to HNBR or FKM is necessary. Consult with Pisco for more information.
- ⑬. Do not stand on a product, or put anything on it. It may cause falls, personal injury or damage to the product.

PDF Compressor Free Version

Warranty

When the product produces a trouble, which is caused by our responsibility, we will carry out either one of the following measures immediately.

- ① .Free-of-charge replacement of same product
- ② .Free-of-charge repair of the product at our factory

Disclaimer

1.PISCO does not take any responsibility for any incidental or indirect loss, such as production line stop, interruption of business, loss of benefits, personal injury, etc., caused by any failure on use or application of PISCO products.

2.When a cause of the trouble/malfunction applies to any of the following items, it is excluded from the coverage of the above warranty.

- ① .A case by a natural disaster, a fire except our responsibility, the act by the third person/party, the intention or fault of the customer.
- ② .A case when a product is used out of the specific range or in a method listed in the product catalog or the instruction manual.
- ③ .A case by the remodeling of the product or by a change of structure, performance, or specifications which PISCO does not involved in.
- ④ .A case by the event that is unpredictable by the evaluations and the measures at the time on or before the initial delivery.
- ⑤ .A case caused by the phenomenon that is able to be evaded if your machine or equipment has functions or structures that are comprised in a common sense when this product is incorporated in your machine or equipment.

3.The damages caused by the defect of Pisco products shall be covered but limited to the full amount of the PISCO products paid by the customer. Additionally, the above warranty is limited simply to the product itself. The damage induced by the trouble of the product will not be compensated.



Common Safety Instructions for Products in This catalog

PDF Compressor Free Version



Caution

1. An odd noise may be heard when supply pressures are immediately before the peak of vacuum levels. The sounding of this odd noise means the characteristics are unstable and the sound may become even noisier. This situation can also adversely affect the sensor, resulting in a malfunction or trouble. So reset the supply pressure.
 - ※ Pressure range in which odd noise occurs is affected by atmospheric pressure.
2. Piping design and equipment selection should be made with an effective sectional area on supply pressure side of a vacuum generator being 3 times as large as the nozzle diameter as a standard. Insufficient air flow may impair the performance of the product.
3. Do not use a lubricator on products.
4. Clean or replace silencer element periodically. There is a possibility of dropping the performance or causing troubles by clogging on the element.
5. Keep products away from water, oil drops or dusts because they are neither drip-proof nor dust-proof. Otherwise there is a possibility of causing malfunction, damage to the products, or dropping the performance.
6. Piping
 - ①. Compressed air contains a volume of drain (water, oxidized oil, tar and foreign material, etc.) Because the drain reduce product performance remarkably, dehumidify air with an aftercooler and a dryer, and improve the air quality.
 - ②. Do not use a lubricator on products.
 - ③. Rust in pipe and inflow of foreign substances cause the trouble, malfunction, and degradation of the product. Please install a filter (5 μ m or better filtration) in the compressed air supply line right in front of the product. The flushing inside the pipe before use and in certain intervals is recommended.
 - ④. Remove dusts or drain before piping. They may get into the peripheral machine / facilities and cause malfunction.
 - ⑤. When inserting an ultra-soft tube into push-in fitting, make sure to place an Insert Ring into the tube edge. There is a risk of causing the escape of tube and a fluid leakage without using an Insert Ring.
 - ⑥. Arrange piping avoiding any load on fittings and tubes such as twist, tensile, moment load, shaking and physical impact. These may cause damages to fittings, tube deformations, bursting and the escape of tubes.
 - ⑦. Install protective cover when using at a place getting the direct sunlight.
 - ⑧. Be sure to confirm each port of a vacuum generator with its appearance drawing or the marking on it before piping. Incorrect piping has a risk of damaging the product.
 - ⑨. Plumb a pressure sensor and a vacuum generator with pressure sensor at the end of vacuum system as much as possible. A long distance between a pressure sensor and a vacuum system end may increase plumbing resistance which may lead to a high vacuum level at the sensor even when no suctioning and a malfunction of pressure sensor. Make sure to evaluate the products in an actual system.
 - ⑩. A Shorter distance of plumbing with a wider bore is preferable at vacuum system side. A long plumbing with a small bore may result in slow response time at the time of releasing work-piece as well as in failure to secure adequate suction flow rate.

- ⑪. In case of using non-PISCO brand tubes, make sure the tolerance of the outer tube diameter is within the limits of Table 1.

●Table 1. Tube O.D. Tolerance

mm size	Nylon tube	Polyurethane tube	inch size	Nylon tube	Polyurethane tube
ø1.8mm	—	±0.05mm	ø1/8	±0.1mm	±0.15mm
ø2mm	—	±0.05mm	ø5/32	±0.1mm	±0.15mm
ø3mm	—	±0.15mm	ø3/16	±0.1mm	±0.15mm
ø4mm	±0.1mm	±0.15mm	ø1/4	±0.1mm	±0.15mm
ø6mm	±0.1mm	±0.15mm	ø5/16	±0.1mm	±0.15mm
ø8mm	±0.1mm	±0.15mm	ø3/8	±0.1mm	±0.15mm
ø10mm	±0.1mm	±0.15mm	ø1/2	±0.1mm	±0.15mm
ø12mm	±0.1mm	±0.15mm	ø5/8	±0.1mm	±0.15mm
ø16mm	±0.1mm	±0.15mm			

7-1. Tube insertion (Push-in fitting)

- ①. Make sure that the cut end surface of the tube is at a right angle without a scratch on the tube surface or deformations.
- ②. When inserting a tube, the tube needs to be inserted fully into the push-in fitting until the tubing edge touches the tube end of the fitting as shown in the figure below. Otherwise, there is a risk of leakage.

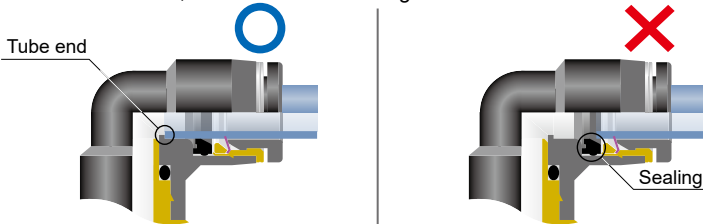

Tube is not fully inserted up to tube end.

- ③. After inserting the tube, make sure it is inserted properly and not to be disconnected by pulling it moderately.
 - ※ When inserting tubes, Lock-claws may be hardly visible in the hole, observed from the front face of the release-ring. But it does not mean the tube will surely escape. Major causes of the tube escape are the followings; ① Shear drop of the lock-claws edge ② The problem of tube diameter (usually small) Therefore, follow the above instructions from ① to ③, even lock-claws is hardly visible.

7-2. Tube insertion (Compression fitting)

- ①. Make sure that the cut end surface of the tube is at a right angle without deformations or a scratch on its inner and outer surface.
- ②. Pass the tube through the nut and insert the barb into the tube up to the barb end. Then tighten the hexagonal-column of the nut with a proper tool.
- ③. Refer to Table 2 which shows the tightening torque.
 - ※ Hold the tube when tightening the nut, since the tube may rotate along with the nut.

- PDF Compressor Free Version
- ④. Make sure that the nut touches the metallic body. If not, loosen the nut, disconnect the tube and start over again from the process ①
 - ⑤. Make sure that there is no leakage after tightening the nut.
 - ⑥. After inserting the tube, make sure it is inserted properly and not to be disconnected by pulling it moderately.

● Table 2. Nut tightening torque

Tube O.D.	Tightening torque
ø10	Max. 4N·m
ø12	Max. 5N·m
ø16	Max. 14N·m

8-1. Tube disconnection (Push-in fitting)

- ①. Make sure there is no air pressure inside of the tube, before disconnecting it.
- ②. Push the release-ring of the push-in fitting evenly and deep enough to pull out the tube toward oneself. By insufficient pushing of the release-ring, the tube may not be pulled out or damaged by scratch, and tube shavings may remain inside of the fitting, which may cause the leakage later.

8-2. Tube disconnection (Compression fitting)

- ①. Make sure there is no air pressure inside of the tube, before disconnecting it.
- ②. Use a proper tool to loosen the nut. Then disconnect the tube.

9. Installation of a fitting

- ①. When installing a fitting, use proper tools to tighten a hexagonal-column or an inner hexagonal socket. When inserting a hex key into the inner hexagonal socket of the fitting, be careful so that the tool does not touch lock-claws. The deformation of lock-claws may result in a poor performance of systems or an escape of the tube.
- ②. Refer to Table 3 in the next page which shows the tightening torque, when tightening a thread. Do not exceed these limits to tighten a thread. Excessive tightening may break the thread part or deform the gasket to cause a fluid leakage. Tightening thread with tightening torque lower than these limits may cause a loosened thread or a fluid leakage. Since the sealability is affected by the processing condition of the installing part, adjust the tightening torque or correct the installing part, according to the condition.
- ③. Adjust the tube direction while tightening thread within these limits, since some PISCO products are not rotatable after the installation.

PDF Compressor Free Version

● Table 3. Tightening torque / Sealock color / Gasket materials

Thread type	Thread size	Tightening torque	Sealock color	Gasket material
Metric thread	M3×0.5	0.7N·m	n/a	SUS304+NBR SPCC+NBR
	M5×0.8	1 ~ 1.5N·m		
	M6×1	2 ~ 2.7N·m		
	M3×0.5	0.7N·m		POM
	M5×0.8	1 ~ 1.5N·m		
	M6×0.75	0.8 ~ 1N·m		
Taper pipe thread	M8×0.75	1 ~ 2N·m	White	—
	R1/8	4.5 ~ 6.5N·m		
	R1/4	7 ~ 9N·m		
	R3/8	12.5 ~ 14.5N·m		
Unified thread	R1/2	20 ~ 22N·m	n/a	SUS304+NBR, SPCC+NBR
	No. 10-32UNF	1 ~ 1.5N·m		
National Pipe Thread Taper (American standard)	1/16-27NPT	4.5 ~ 6.5N·m	White	—
	1/8-27NPT	4.5 ~ 6.5N·m		
	1/4-18NPT	7 ~ 9N·m		
	3/8-18NPT	12.5 ~ 14.5N·m		
	1/2-14NPT	20 ~ 22N·m		
G thread	G1/4	12 ~ 14N·m	n/a	Aluminum + PBT
	G3/8	22 ~ 24N·m		
	G1/2	28 ~ 30N·m		

※ These values may differ for some products. Refer to each specification as well.

- ④ When removing a fitting, use proper tools to loosen a hexagonal-column. When inserting a hex key into the inner hexagonal socket of the fitting, be careful so that the tool does not touch lock-claws. The deformation of lock-claws may result in a poor performance of systems or an escape of the tube.
- ⑤ Remove the sealant stuck on the mating equipment. The remained sealant may get into the peripheral equipment and cause malfunctions.

10. Handling of PISCO products

- ① Impact caused by dropping or the like may lead to damage to the product and a fluid leakage.

11. PISCO products shall be used within the Operating temp. range, including the heat of the product itself generated by adiabatic compression.

PDF Compressor Free Version

The additional suction holes have significantly improved the suction flow rate and suction force.

Vacuum Pad Flat series Large Suction Flow Type



Vacuum Pad

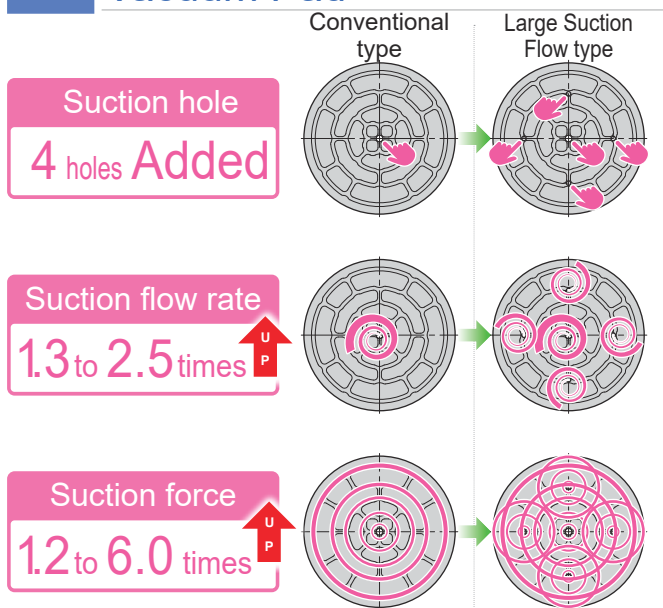

Pad Screw

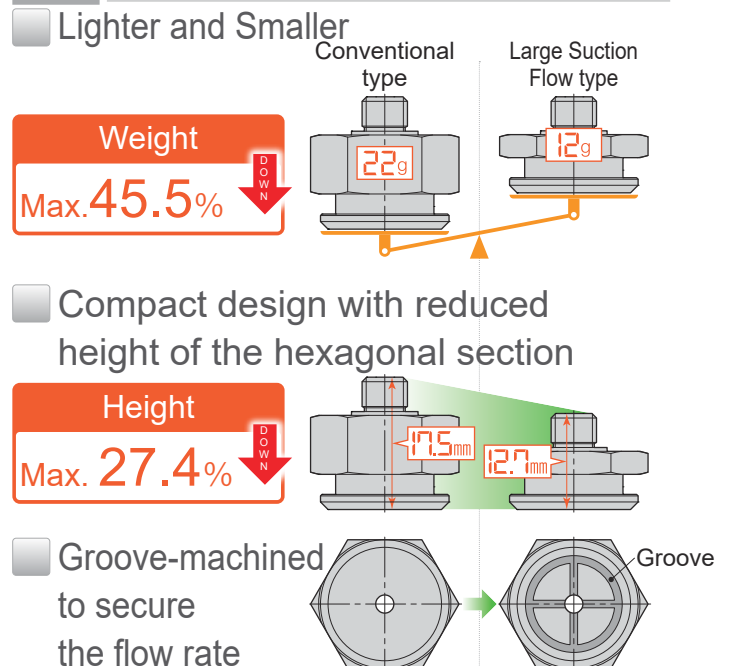

Model designation of Pad (Rubber only) (Example)

VP **20** **FH** **S**

① Vacuum Pad

② Pad size

Code	10	15	20	25	30
Size (mm)	ø10	ø15	ø20	ø25	ø30
Connection config. code	-M4		-M6		

③ Pad type

Code	FH	F
Type	Large suction flow type	Flat (Conventional type)

④ Pad material

Code	N	S	F	NE	SE
Rubber material	Nitrile rubber	Silicone rubber	Fluoro rubber	Conductive NBR (Low resistance)	Conductive silicone
Color	Black	Natural (Ivory)	Gray	Black	

Model designation of Pad & screw set (Example)

VP **20** **FH** **S** **-M6**

① Vacuum Pad

② Pad size

Code	10	15	20	25	30
Size (mm)	ø10	ø15	ø20	ø25	ø30

③ Pad type

Code	FH	F
Type	Large suction flow type	Flat (Conventional type)

④ Pad material

Code	N	S	F	NE	SE
Rubber material	Nitrile rubber	Silicone rubber	Fluoro rubber	Conductive NBR (Low resistance)	Conductive silicone

⑤ Connection configuration code

Code	-M4	-M6
Thread size	M4×0.7	M6×1
Applicable pad size	ø10, ø15	ø20~ø30

⑥ -S3 spec.

Code	No code	-S3
Spec.	Standard	Metal parts : Copper alloy free material Seal parts : FKM or HNBR

It can also be mounted on the conventional Flat type (F), but to secure the suction flow rate, Large suction flow type (FH) and the pad screw shall be used as a set.

△ Safety instructions

- △ Caution 1. To select a suitable model code, please carry out a suction test under actual conditions, referring to the following caution.
 - (1) Vacuum pad flat series may have difficulty in suction and conveyance of work-piece with air permeability or work-piece that easily deforms by its own weight.

Vacuum Pad dimensions

VP10FH(4)

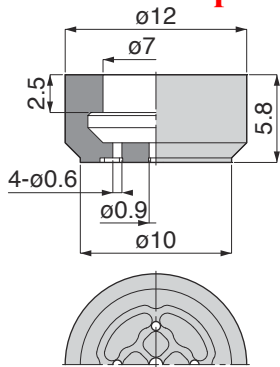

VP15FH(4)

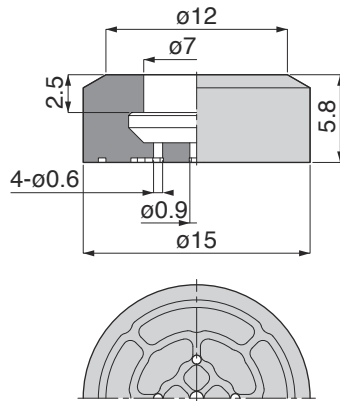

VP20FH(4)

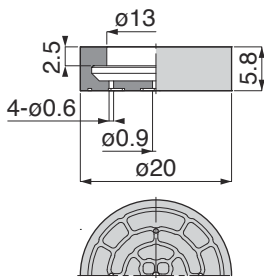

VP25FH(4)

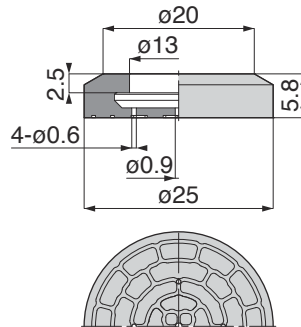

VP30FH(4)

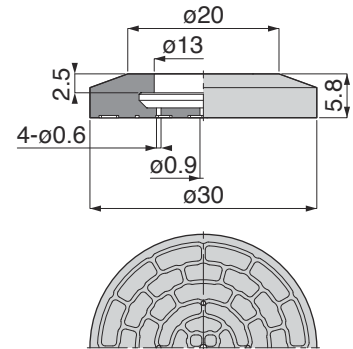

Unit : mm

Model code	Weight (g)				
	(4) Pad material code				
	N	S	F	NE	SE
	Nitrile rubber	Silicone rubber	Fluoro rubber	Conductive NBR (Low resistance)	Conductive silicone
VP10FH(4)	0.5	0.5	0.8	0.5	0.5
VP15FH(4)	1	0.9	1.5	1	0.9
VP20FH(4)	1.3	1.2	2	1.3	1.2
VP25FH(4)	2.4	2.2	3.7	2.3	2.2
VP30FH(4)	3.3	3.1	5	3.3	3.1

Pad screw dimensions

FVPLFH15-M4(6)

Weight : 3.8g

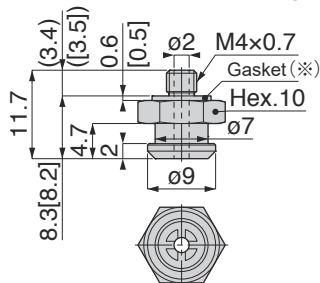

FVPLFH30-M6(6)

Weight : 12g

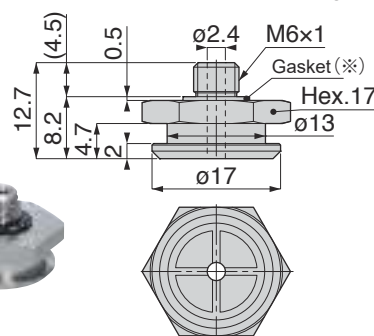

Unit : mm

Model code
FVPLFH15-M4(6)
FVPLFH30-M6(6)

※) The dimensions in [] are for the -S3 specification.

※) Gasket material for standard spec. (6) : No code) is SUS304+NBR.
Gasket material for -S3 spec. (6) : -S3) is SUS316+FKM.

Dimensions of Pad & screw set

PDF Compressor Free Version



VP²FH⁴-M⁴⁶

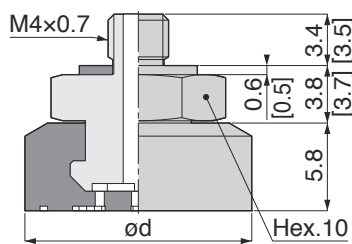

VP²FH⁴-M⁶⁶

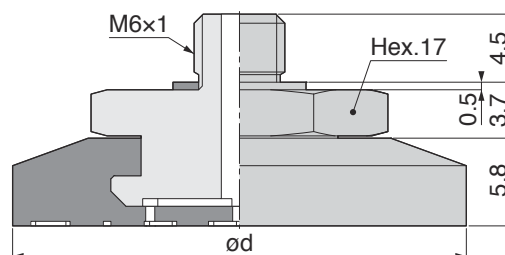

Unit : mm

Model code	ød	Weight (g)					Connection config. code
		Pad material code					
		N	S	F	NE	SE	
		Nitrile rubber	Silicone rubber	Fluoro rubber	Conductive NBR (Low resistance)	Conductive silicone	
VP10FH ⁴ -M ⁴ ⁶	10	4.3	4.2	4.5	4.3	4.2	-M4
VP15FH ⁴ -M ⁴ ⁶	15	4.7	4.7	5.3	4.7	4.7	
VP20FH ⁴ -M ⁶ ⁶	20	14	14	14	14	14	-M6
VP25FH ⁴ -M ⁶ ⁶	25	15	15	16	15	15	
VP30FH ⁴ -M ⁶ ⁶	30	16	16	17	16	16	

※1) ⁶ : Replaced with "-S3" for -S3 spec. (Copper alloy free material for metal parts and FKM or HNBR for sealing parts).

The weight for standard spec. and -S3 spec. are same.

※2) Pad material N and NE are not suitable for use under ozone environment.

※3) The dimensions in [] are for the -S3 specification.

Please use in combination with the vacuum pad holder alone. Pad connection config. code: -M4 or -M6 can be selected.

List of connection type and other information required for the connection of the holder and the pad (size) of your choice

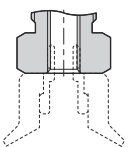
Pad dia. (mm)	Pad rubber Model code	Pad connection type	Connection config. code	Pad & screw set Model code	Complement parts model code
					Pad screw
ø10	VP10FH ⁴	Screw type (Connection with screw) 	-M4	VP10FH ⁴ -M ⁴ ⁶	FVPLFH15-M ⁴ ⁶
ø15	VP15FH ⁴			VP15FH ⁴ -M ⁴ ⁶	
ø20	VP20FH ⁴		-M6	VP20FH ⁴ -M ⁶ ⁶	FVPLFH30-M ⁶ ⁶
ø25	VP25FH ⁴			VP25FH ⁴ -M ⁶ ⁶	
ø30	VP30FH ⁴			VP30FH ⁴ -M ⁶ ⁶	

Vacuum pad holder configuration diagram for Connection configuration code : -M4

PDF Compressor Free Version

Pad dia. : ϕ 10, ϕ 15mm

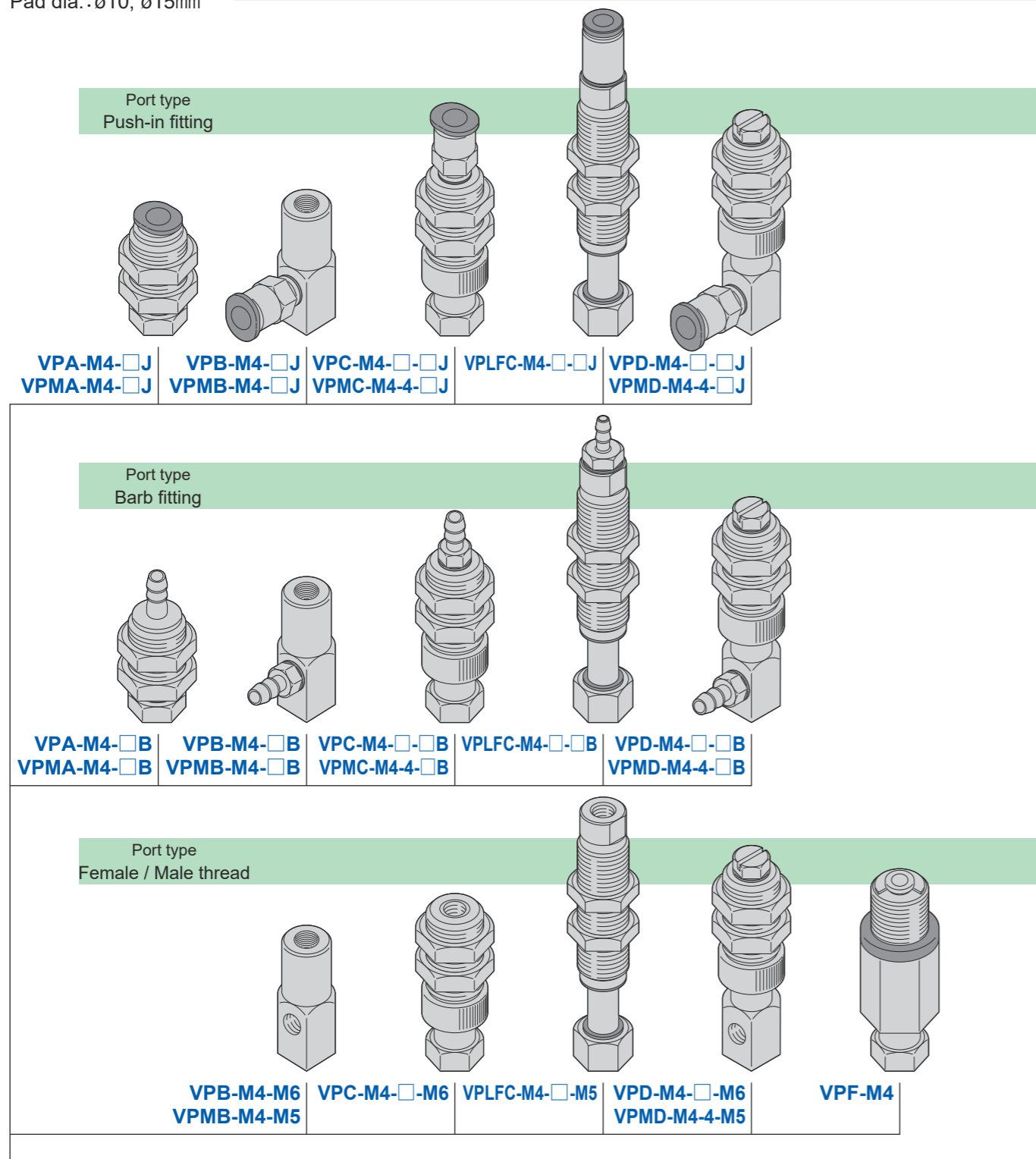

Flat series Large suction flow type + Pad screw set

Model code	Pad dia.
VP10FH(4)-M4	ϕ 10mm
VP15FH(4)-M4	ϕ 15mm

Flat series Large suction flow type + Pad screw set

Model code	Pad dia.
VP20FH(4)-M6	ϕ 20mm
VP25FH(4)-M6	ϕ 25mm
VP30FH(4)-M6	ϕ 30mm

Vacuum pad holder configuration diagram for Connection configuration code : -M6

Pad dia. : ϕ 20, ϕ 25, ϕ 30mm

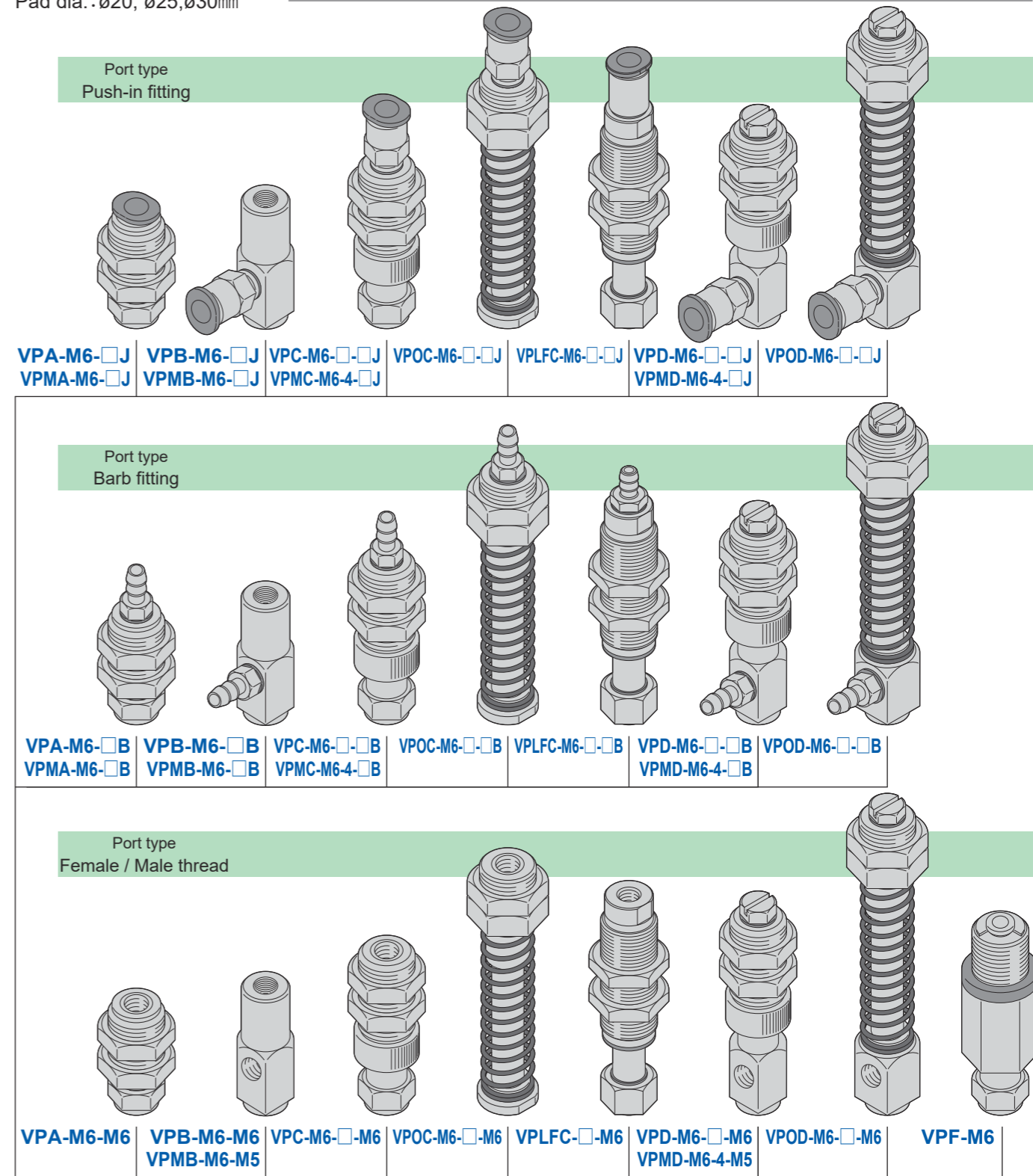

NIHON PISCO CO.,Ltd.

OVERSEAS SALES DEPARTMENT (HQ)	TEL. +81-(0)265-76-7751	FAX. +81-(0)265-76-3305	e-mail. intl@pisco.co.jp
PISCO TAIWAN CO.,LTD	TEL. +886-(0)6-782-0701	FAX. +886-(0)6-782-0710	e-mail. P8638@ms16.hinet.net
NIHON PISCO TAIWAN CO.,LTD	TEL. +886-(0)6-726-4520	FAX. +886-(0)6-726-1526	
PISCO USA, INC.	TEL. +1-630-993-3500		e-mail. inquiry@pisco.com
PISCO KOREA CO.,LTD	TEL. +82-32-327-9795	FAX. +82-32-327-0385	e-mail. webmaster@pisco.co.kr
NIHON PISCO CO., LTD. BANGKOK REPRESENTATIVE OFFICE	TEL. +66-(0)2-612-7366	FAX. +66-(0)2-612-7399	e-mail. piscobkk@pisco.co.jp
PISCO VIETNAM CO., LTD	TEL. +84-24-3200-0310	FAX. +84-24-3200-5331	e-mail. piscovina2018@pisco-vn.com
NIHON PISCO Co., Ltd. SHANGHAI REPRESENTATIVE OFFICE	TEL. +86-21-31332623		e-mail. ribenpisco@gmail.com

>>> <https://en.pisco.co.jp/>