

Single acting type



Wide Stroke with Miniature body

The smallest body as a 6mm stroke in the industry. (internal investigation)

10mm width (.39") model is the lightest in the industry (internal investigation).

A small gripper with secure gripping.

Single acting gripper yet can be used either Normally Open or Normally Closed.

Eco design - single acting saves air consumption.

Parallel gripper single acting type

Model designation (Example)

CHA10
①

①. Model number

Code	Type	Body width (mm)	Countermeasure lateral load	Stroke (mm)
CHA08	Single acting	10	N/A	4
CHA10		14	N/A	6
CHA10E			E shape retainer ring	

Model Designation for Attachment (Ex.)

CHK ① **10** ②

②. Applicable gripper model

Code	08	10
Applicable gripper model	CHA08	○
	CHA10(E)	○

①. Attachment for parallel gripper

Specification

Fluid medium	Clean air (Restricted to filtered compressed air)
Operating pressure range	43.5~72.5psi (0.3 ~ 0.5MPa)
Operating temperature range	40 ~ 120° F (5~50° C) (no freezing)
Lubrication	No Lubrication
Maximum operating cycle	180cpm

Structure

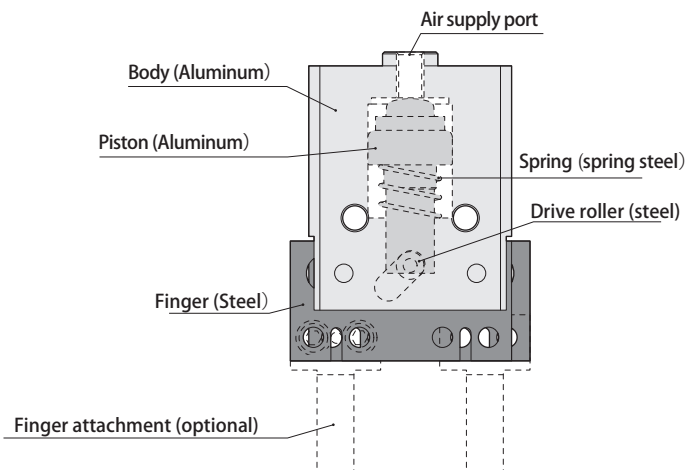

Characteristics

Type	Model		Stroke (mm)	Effective gripping force (N)		Maximum Load (N)	
	Standard model	with E shape retainer (Countermeasure lateral load)		Force by air	Force by spring	F1	F2
Single acting	CHA08	CHA10E	4	4.2	1	5	2.5
	CHA10		6	7.2	1.3	10	5
Remark				※1	※2, 3, 4		

※1. The effective gripping force by air is the value at supply air 0.4MPa and gripping point L 20mm

※2. The maximum load means allowable static load but does not mean the whole range of finger moving.

※3. The maximum load is just reference but not guaranteed value. Please take enough tolerance into consideration and minimize external forces.

※4. The direction of the maximum load →

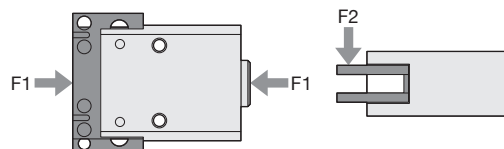

Effective gripping force

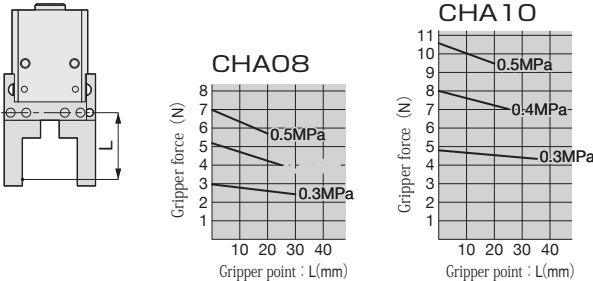

Maximum gripping distance

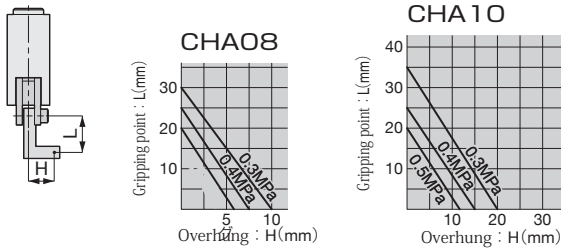

Gripping style

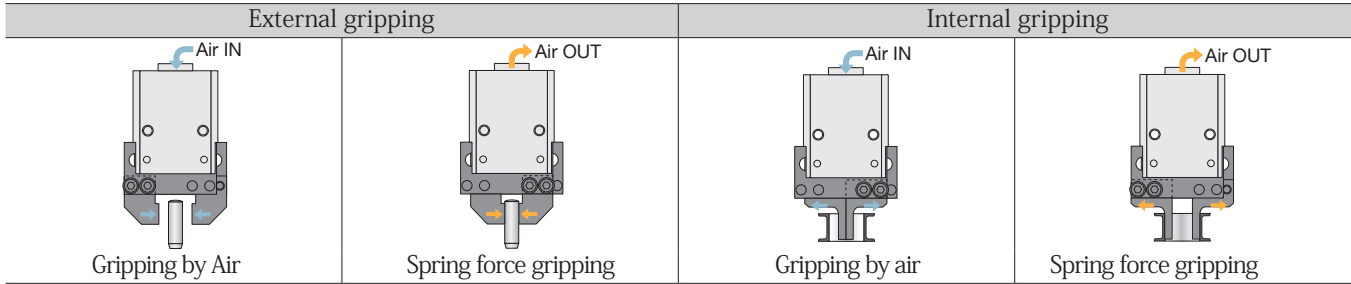

Detailed Safety Instrucitons

Before using PISCO products, be sure to read "Safety Instructions" and "Safety Instruction Manual" and "Common Safety Instructions for Grippers and Actuators".

Dimensions

CHA08 Parallel gripper single acting (Body width : 10mm) type

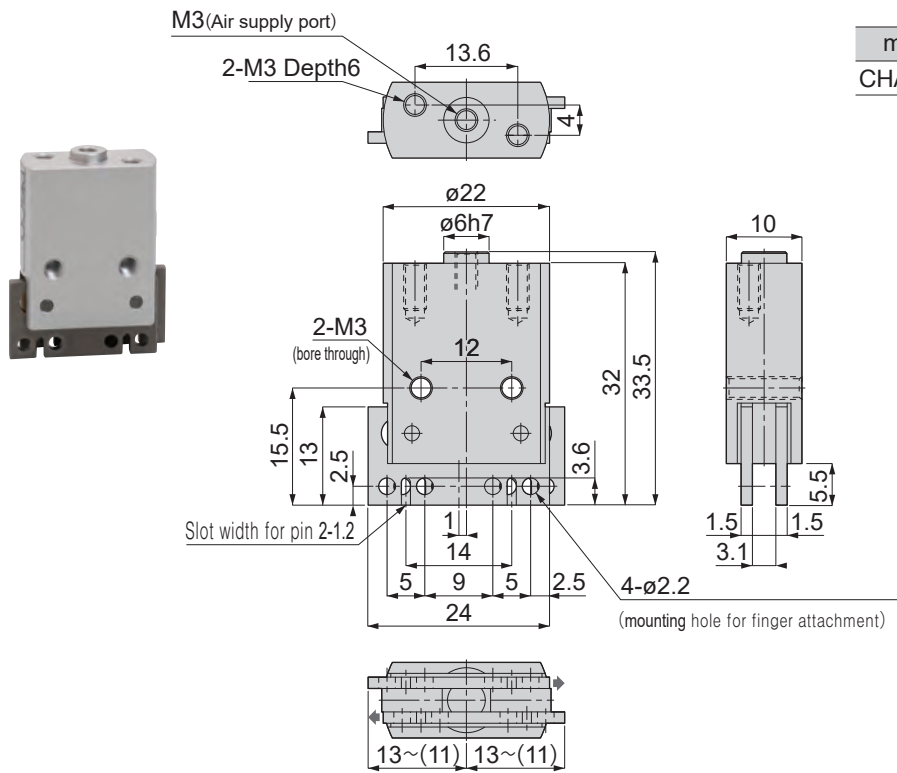

Unit : mm		
model	Wt. (g)	Price (\$)
CHA08	18	213.64

- ※1. The chart is of the condition with no air-supply.
- ※2. Two fingers are all same designed (shared).
- ※3. When pressurized, each finger moves 2mm towards the arrow direction respectively.

CHK08 Attachment for Parallel gripper (body width : 10mm)

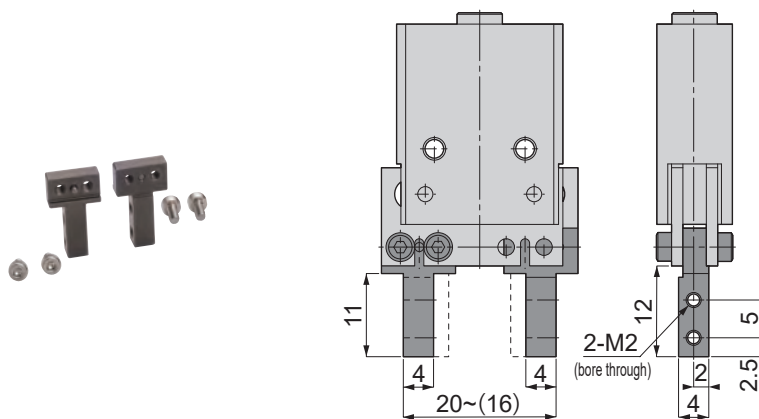

Unit : mm		
Model	Wt. (g)	Price (\$)
CHK08	6	45.45

- ※1. The above chart is of Parallel gripper single acting type (body width : 10mm) with Attachment installed.
- ※2. Attachment consists of two sets of same spare parts (same design).

⚠ Common Safety Instruction for Parallel Grippers

1. Handling instruction

1-1. Where to install

Magnet is incorporated inside the gripper body. Please pay attention when you use it in certain circumstance like a pile of metal powers, sensor switches, metal etc.

※ Please use single acting type CHA08 · CHA10 where magnetic material is not accepted.

2-2. Installation

Install through the mounting thread holes whenever used on pick and place machines or robotic arms.

● Tighten the screws in accordance with the torque mentioned below. Over tightening can cause shortening life cycles nor dropping function.

Screw size	Tightening Torque (N·m)
M2.6	0.39
M3	0.88
M4	1.7

- If the surface of the plate where the gripper installed is uneven, it can deform the cylinder and cause malfunction.
- In case of side mounting, use the holes tapped on the side of the body. Using inappropriate long screws may cause deforms inside the cylinder and malfunctions. Use the appropriate installation screws in accordance with the chart 1 below
- In case of side mounting, provide a clearance space so that the part around the fingers does not get in contact since the portion tends to be deformed. (Chart 1 ②)
- The tapped holes on the side are though holes. Do not install it by pinching the body with small threads which go through the holes. After all, the installation is unstable and could be a cause of malfunction. (Chart 2)

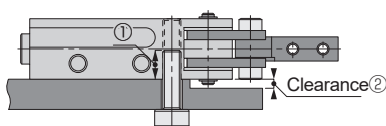

Thread size	Thread length ①
M3	5mm max.
M4	8mm max.

Chart 1

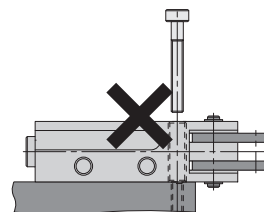

Chart 2

2. Attachments

● Refer to Chart3-1 ~ Chart3-4 for attachments installation. The position of finger installation changes depending on the gripping style.

Single acting	External gripping by air	Refer to Chart 3-1
	Internal gripping by air	Refer to Chart 3-2
	External gripping by spring	Refer to Chart 3-3
	Internal gripping by spring	Refer to Chart 3-4
Double acting	External gripping	Refer to Chart 3-1
	Internal gripping	Refer to Chart 3-2

Gripping by air

Gripping by spring

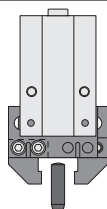

External
Chart 3-1

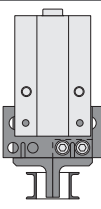

Internal
Chart 3-2

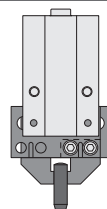

External
Chart 3-3

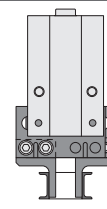

Internal
Chart 3-4

● Make attachments lighter, shorter within the distance of maximum gripping and gripping within the distance of fingers.

■ Distance of maximum gripping

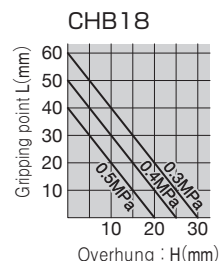
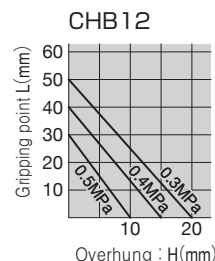
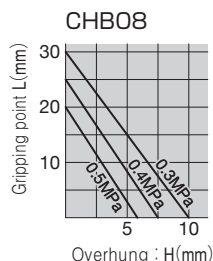
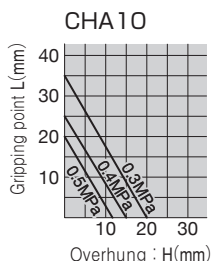
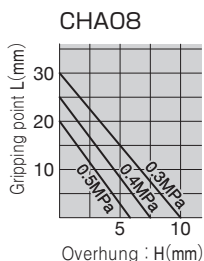
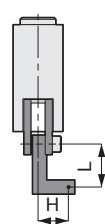

- The length of attachment installation screws should be within A distance in the chart mentioned below. If the screws are longer than the distance, they push and damage the other finger on the opposite side.

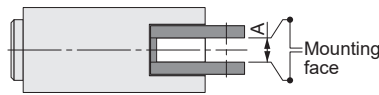

Model	A inch (mm)
CHA08	0.118" (3)
CHA10	0.157" (4)
CHB08	0.118" (3)
CHB12	0.157" (4)
CHB18	0.236" (6)

- Attachments should be installed on the mounting face by using mounting holes. When installing, do not tap nor twist the fingers, which can cause damages or shortening the life cycles. Do not put any force on the body like clamping by a vise or a spanner (Chart 4)

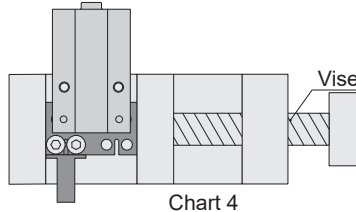

Chart 4

- The reference slot of the finger can be used as a mounting reference. When the attachments are customized, fix the parallel pin type B (Chart 5) on the attachment then put into the slot. Do not tap or twist the fingers when putting into the slot. Provide the pin by yourselves.

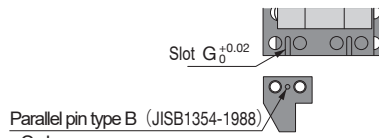

Chart 5

Model	G inch (mm)	L inch (mm)
CHA08	0.047" (1.2)	0.157" (4)
CHA10		0.157" (4)
CHB08	0.047" (1.2)	0.197" (5)
CHB12		0.197" (5)
CHB18	0.059" (1.5)	0.315" (8)

- Mounting surface of the finger is as Chart 6. When mounting a wide attachment, the clearance is needed to avoid the contact with another finger. Make sure the fingers move freely by hands after mounting the attachments.

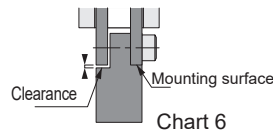

Chart 6

- Use the following cap screws for installation. Apply screw glue on the thread. Avoid applying excessive volume of glue because it may stick around fingers and body, which can cause any malfunctions

Model	Thread size	Tightening torque (N·m)
CHA08	M2	0.315
CHA10	M3	1.14
CHB08	M2	0.315
CHB12	M3	1.14
CHB18	M4	2

- In case of mounting a jaw from the direction in Chart 9 mentioned below, do not put force to the body as clamping the jaw by a monkey wrench or a like. Mounting a jaw with holding the body may cause damages or malfunctions.

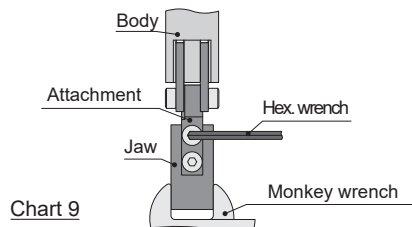

Chart 9

3. Piping method

3-1. Piping

Single acting type has one air supply port and Multi-acting type has two. Install fittings as per chart 10 and connect tubings.

- Small fittings like barb fittings are preferable since push-in type fittings may make contacts with mounting brackets or sensors.

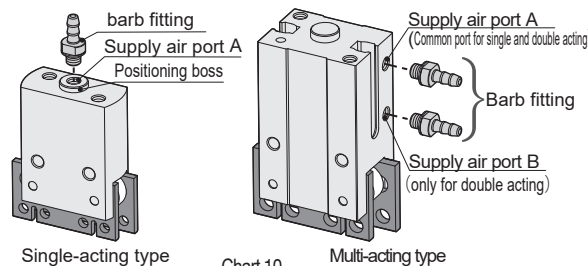

Chart 10

Use multi-acting type as single acting

Put a fitting on port A only. Pressurizing the port pushes the piston which makes the drive roller to close the fingers. (See chart 11)

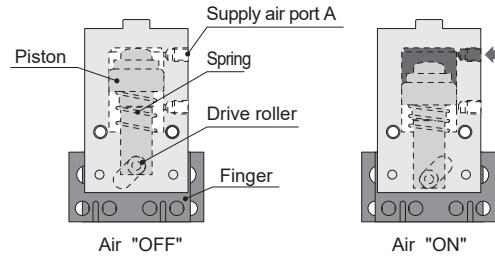

Chart 11

Use multi-acting type as double acting

Attach fittings on both supply port A and B. Pressuring the supply port A pushes the piston and makes the drive roller to close the fingers. Pressuring the supply port B pushes up the piston and makes the drive roller back and open the fingers. (See chart 12)

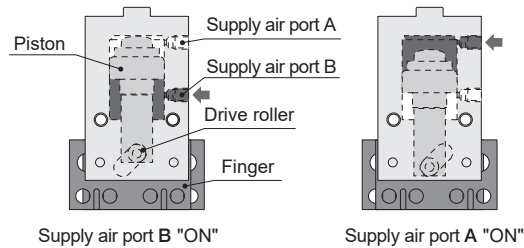

Chart 12

3-2. Piping instruction

- To enhance air power efficiency, piping the tubing as short as possible. Install a meter-in flow control valve closer to all the single-acting type grippers and single acting use of multi-acting type grippers and install meter-out control valves closer to double acting use of multi-acting type grippers. Adjust the speed of opening/closing as slow as possible.

4. Running

4-1. Check motion

To check the motion of gripper mounted on a pick and place machine or robotic arm, turn off the electrical supply check the motion of gripper by manual operation of valve. Do not put a finger/hand between the fingers/finger attachments of the gripper.

4-2. Running

After the motion check is done, confirm the machine is running properly turning on the power supply. If necessary, do debugging before running the system.

- In case of gripping by spring, depending on the piping system, the gripping force may not come out right within the time. Check the functions at the time of adjustment.
- After a long standby time with being pressurized, the performance may delay at the initial operation. Actuate the grippers several times as warming-up before resuming the operation.

5. Installing sensor switches

- Put the sensor switch into the mounting slot and place it to the position (the center of working range) and tighten the set screw.

Installation example

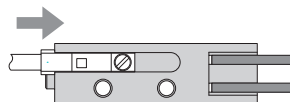

Slide the sensor switch to the arrow direction then the light is on.

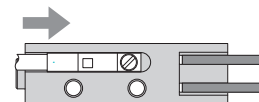

Slide the sensor switch another 0.33mm to the arrow direction and fit it with set screw.

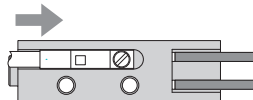

Keep sliding the sensor switch to the arrow direction. The light turns on then turns off.

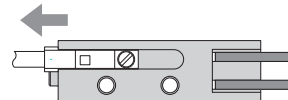

Slide backward to the point where the light is on. Slide back another 0.3 mm and fix it by tightening the set screw.

- Use the precision screw driver for tightening the set screw with 0.1~0.2N·m as tightening torque.