

**100KSPS 16-bit
Analog Input Unit for USB
AI-1664LAX-USB**



* Specifications, color and design of the products are subject to change without notice.

Features

High-precision analog input 64 channels, each 4 channels for digital I/O and counter 1 channel

This product has analog input (10μsec / channel, 16-bit, 64 channels), analog input control signal (LVTTTL level 3 channels), digital I/O (each 4 channels for LVTTTL level) and counter (32-bit, LVTTTL level 1 channel). Capable of setting the analog input at single-ended input 64 channels and differential input 32 channels.

The start/end of sampling can be controlled by software, comparison of conversion data, an external trigger, etc.

You can select from software, comparison of conversion data or an external trigger to control the start of sampling. You can select from completion of sampling for a specified number of sessions, comparison of conversion data, an external trigger or software to control forcibly the end of sampling. The sampling cycle can be selected from the internal clock or an external clock.

Equipped with buffer memory (1K data) that can be used in the FIFO or RING format

The analog input block contains buffer memory (1K data) that can be used in the FIFO or RING format. This allows for background analog input that does not depend on the operation status of the software or PC.

Digital filter function included to prevent misdetection due to chattering on external signals

A digital filter is included to prevent misdetection due to chattering on the control signal (external trigger input signal, sampling clock input signal, etc.), digital input signal and counter input signal. (except from external clock input signal and counter gate signal)

Compatible with PCI / PCI Express bus board in it's design. Common connector shape and pin assignment with PCI / PCI Express bus board

This product has the common connector shape and pin assignment with PCI bus board AD16-64(LPCI)LA, PCI Express bus board AI-1664LA-LPE so you can use the common cables and accessories, it is easy to migrate from the existing system *1.

Compatible to USB1.1/USB2.0

Compatible to USB1.1/USB2.0 and capable to achieve high speed transfer at HighSpeed (480 Mbps).

USB HUB function, the CONTEC's USB supported products (Max. 4) can be used.

This product has the USB HUB function. *2 Max. 4 AI-1664LAX-USB can be used in 1 USB port of PC. When you use 4 or more AI-1664LAX-USB, you can do by connecting AI-1664LAX-USB to the another USB port of

This product is a USB2.0-compliant analog input unit that extends the analog input function of USB port of PCs. This product is multi-channels and multifunction type with 16-bit analog input 64 channels (single-ended input 64 channels or differential input 32 channels), digital I/O and counter function. This product carries buffer memory for 1K of data, allowing sampling to be performed in a variety of trigger / clock conditions.

As there is compatible with PCI bus-compatible board AD16-64(LPCI)LA and PCI Express bus-compatible board AI-1664LA-LPE in terms of connector shape and pin assignments, it is easy to migrate from the existing system.

Windows/Linux driver is supported with this product.

- *The contents in this document are subject to change without notice.
- *Visit the CONTEC website to check the latest details in the document.
- *The information in the data sheets is as of October, 2022.

PC side. Also, you can connect the CONTEC's USB supported products other than AI-1664LAX-USB to the USB port of AI-1664LAX-USB. *3*4

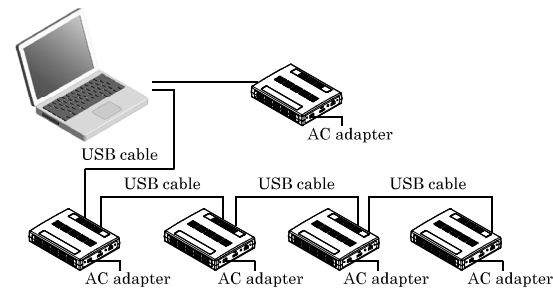

Software-based calibration function

Calibration of analog input can be all performed by software. Apart from the adjustment information prepared before shipment, additional adjustment information can be stored according to the use environment.

Windows/Linux compatible driver libraries.

Using the analog I/O driver makes it possible to create applications of Windows/Linux. In addition, a diagnostic program by which the operations of hardware can be checked is provided.

Plug-ins for the dedicated libraries, this product also supports MATLAB and LabVIEW.

We offer a dedicated library [ML-DAQ], which allows you to use this product on MATLAB by The MathWorks as well as another dedicated library [VI-DAQ], which allows you to use the product on LabVIEW by National Instruments. These dedicated libraries are available, free of charge (downloadable), on our web site.

- *1 There are some differences of the specifications between this product and AI-1664LA-LPE, AD16-64(LPCI)LA. For more details on this, refer to "Chapter7, Difference from AI-1664LA-LPE, AD16-64(LPCI)LA"
- *2 This product cannot be stacked up for installation.
- *3 Do not connect the device other than that of CONTEC's USB to the USB port included on the AI-1664LAX-USB. Otherwise, this may cause a failure or malfunction.
- *4 When connecting multiple units with USB HUB function and set up them, do one at a time and complete setup for the previous unit before starting to do the next unit.

Specifications

Hardware specifications

Item	Specification
Analog input	
Isolated specification	Non-isolated
Input type	Single-Ended Input or Differential Input (by software)
Input channel	64ch (single-ended input), 32ch (differential input)
Input range	Bipolar ±10V
Absolute max input voltage	±20V
Input impedance	1MΩ or more
Resolution	16Bit
Non-Linearity error *1 *2	±5LSB
Conversion speed	10μ sec/ch
Buffer memory	1k Word
Conversion start trigger	Software / external trigger
Conversion stop trigger	Number of sampling times / external trigger/software
External start signal	LVTTL level (Rising or falling edge can be selected by software) Digital filter (1μsec can be selected by software)
External stop signal	LVTTL level (Rising or falling edge can be selected by software) Digital filter (1μsec can be selected by software)
External clock signal	LVTTL level (Rising or falling edge can be selected by software) Digital filter (1μsec can be selected by software)
Digital I/O	
Number of input channels	Non-isolated input 4channels (LVTTL level positive logic)
Number of output channels	Non-isolated output 4channels (LVTTL level positive logic)
Counter	
Number of channels	1channel
Counting system	Up count
Max. count	FFFFFFFF (Binary data, 32bit)
Number of external inputs	LVTTL level : 2 (Gate/Up)/ch, Gate (High level), Up (Rising edge)
Number of external outputs	LVTTL level : 1/ch, Count match output (positive logic, pulse output)
Frequency response	10MHz (Max)
USB	
Bus specification	USB Specification 2.0/1.1 standard
USB transfer rate	12Mbps (Full-speed), 480Mbps (High-speed) *3
Power supply	Self power *4
Attached AC adaptor (POA200-20-2)	90 - 264VAC 5.0VDC±5% 2.0A (Max) Cable length : about 1.5m, AC Cable length : about 1.5m
Common section	
Number of terminals used at the same time	63 terminals (Max) *5
Power consumption (Max)	5VDC 670mA
Operating condition*6	0 - 50°C, 10 - 90%RH (No condensation) * When using the attached AC adaptor POA200-20-2, it is 0 - 40°C
Physical dimensions (mm)	180 (L) x 140 (D) x 34 (H) (No protrusions)
Weight	400g(Not including the USB cable, attachment)
Connector	68 pin 0.8mm pitch connector HDRA-E68W1LFDT-SL [HONDA] or equivalent to it
Attached cable length	USB Cable 1.8m
Standard	VCCI Class A, FCC Class A CE Marking (EMC Directive Class A, RoHS Directive), UKCA

- *1 A linearity error approximately 0.1% of full-range may occur when operated at 0°C or 50°C ambient temperature.
- *2 At the time of the source use of a signal which built in the high-speed operational amplifier.
- *3 The USB transfer speed depends on the host PC environment used (OS and USB host controller).
- *4 The supplied current is insufficient in the bus power. Please use the attached AC adaptor (POA200-20-2).
- *5 As a USB hub is also counted as one device, you cannot just connect 63 USB terminals.
- *6 To suppress the heating, ensure that there are spaces for ventilation (about 5cm) around this product.

AC adaptor environmental condition (environmental specification)

Item	Specification
Input voltage range	90 - 264VAC
Rated input current	300mA
Number of frequency	50 - 60Hz
Rated output voltage	5.0VDC
Rated output current	2.0A (Max)
Dimension (mm)	47.5 (W) x 75 (D) x 27.3 (H) (No protrusions)
Weight	175g
Operating temperature	0 - 40°C
Operating humidity	20 - 80%RH(No condensation)
Life expectancy	4 years at the ambient temperature 40°C (When 100VAC is input and 1.3A is output)
Allowable time of short interruption	15ms (Max) (When 100VAC is input and 1.3A is output) *1
Floating dust particles	Not to be excessive
Corrosive gases	None
Voltage corresponding to the attached AC cable	125VAC 7A

- *1 When the short interruption occurs and the defective operation of the equipment is generated, please insert the power supply of the equipment after pulling out it.

Physical dimensions

Physical dimensions (AI-1664LX-USB)

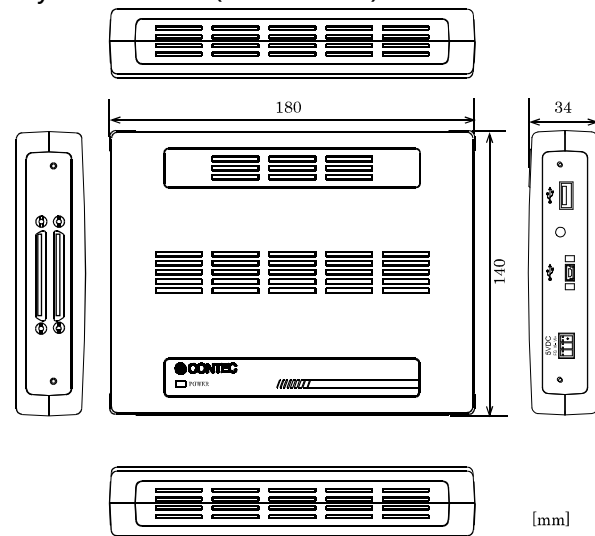

Physical dimensions of attached AC adaptor (POA200-20-2)

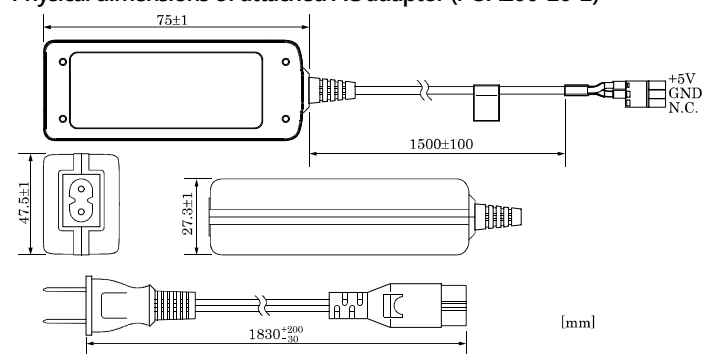

Support Software

Windows version of analog I/O driver API-AIO(WDM)

The API-AIO(WDM) is the Windows version driver library software that provides products in the form of Win32 API functions (DLL). Various sample programs such as Visual Basic and Visual C++, etc and diagnostic program useful for checking operation is provided. For more details on the supported OS, applicable language and how to download the updated version, please visit the CONTEC's Web site.

Data Logger Software C-LOGGER

C-LOGGER is a data logger software program compatible with our analog I/O products. This program enables the graph display of recorded signal data, zoom observation, file saving, and dynamic transfer to the spreadsheet software "Excel". No troublesome programming is required. For more details on the supported OS, applicable language and how to download the updated version, please visit the CONTEC's Web site.

Data Acquisition library for MATLAB ML-DAQ

This is the library software which allows you to use our analog I/O device products on MATLAB by the MathWorks. Each function is offered in accordance with the interface which is integrated in MATLAB's Data Acquisition Toolbox. See CONTEC's Web site for details and download of ML-DAQ.

Data acquisition VI library for LabVIEW VI-DAQ

This is a VI library to use in National Instruments LabVIEW. VI-DAQ is created with a function form similar to that of LabVIEW's Data Acquisition VI, allowing you to use various devices without complicated settings. See CONTEC's Web site for details and download of VI-DAQ.

Cable & Connector (Option)

Shielded cables with two-ended connector for 68-pin half-pitch connector

: PCB68PS-0.5P (0.5m), PCB68PS-1.5P (1.5m)

Shielded cables with single-ended connector for 68-pin half-pitch connector

: PCA68PS-0.5P (0.5m), PCA68PS-1.5P (1.5m)

68/96-pin conversion shielded cable for analog input/output

: ADC-68M/96F (0.5m)

* Two sets of cables are required to use both connector CNA and CNB.

Accessories (Option)

Terminal Unit for Cables (M3 x 96P) : DTP-64A *1*3

Screw Terminal (M3 x 68P) : EPD-68A *2*3*4

Screw Terminal (M3 x 96P) : EPD-96A *1*3*4

Screw Terminal (M3.5 x 96P) : EPD-96 *1*3

BNC Terminal Unit (analog input 32ch) : ATP-32F *1*3

BNC Terminal Unit (analog input 8ch) : ATP-8 *1*3*5

USB I/O Unit Bracket for X Series : BRK-USB-X

AC adaptor (input: 90 - 264VAC, output: 5VDC 2.0A)
: POA200-20-2 *6

DC-DC power supply unit (input: 10 - 30VDC, output: 5VDC 3.0A)
: POW-DD10GY

*1 ADC-68M/96F optional cable is required separately.

*2 PCB68PS-0.5P or PCB68PS-1.5P optional cable is required separately.

*3 Two sets of cables are required to use both connector CNA and CNB.

*4 "Spring-up" type terminal is used to prevent terminal screws from falling off.

*5 Can be used in CNA channels 0 - 7 or CNB channels 32 - 39.

*6 It is the same as the one appended to the product. Please buy it necessary for maintenance.

* For details on the range channels available to each terminal panel, see Figure 3.2 "Connecting example of option".

* Check the CONTEC's Web site for more information on these options.

Difference from AI-1664LA-LPE and AD16-64(LPCI)LA

Item	AI-1664LAX-USB	AI-1664LA-LPE	AD16-64(LPCI)LA
Analog input			
External start signal, External stop signal, External clock signal	LVTTTL level		TTL level
Digital I/O			
Number of input channels	Non-isolated input 4 channels (LVTTTL level positive logic)		Non-isolated input 4 channels (TTL level positive logic)
Number of output channels	Non-isolated output 4 channels (LVTTTL level positive logic)		Non-isolated output 4 channels (TTL level positive logic)
Counter			
Number of external inputs	LVTTTL level		TTL level
Number of external outputs	LVTTTL level		TTL level
Power consumption	5VDC 670mA (Max)	3.3VDC 620mA(Max)	5VDC 450mA (Max)
Bus specification	USB Specification 2.0/1.1 standard	PCI Express Base Specification Rev. 1.0a x1	PCI(32bit, 33MHz, Universal key shapes supported)
Physical dimensions (mm)	180(L) x 140(D) x 34(H) (No protrusions)	121.69(L) x 67.90(H)	121.69(L) x 63.41(H)
Weight	400g (Not including the USB cable, attachment)	90g	60g

Packing List

Unit [AI-1664LAX-USB] ...1

AC adaptor ...1

AC Cable (for 125VAC)...1

USB cable (1.8m) ...1

USB cable attachment on the main unit's side (For Mini B connector side) ...1

Clamps for prevention of cable on the main unit's side ...1

Setup Guide ... 1

Power connector MC1,5/3-ST-3,5 ...1

Ferrite core ...1

Warranty Certificate ...1

Serial number label ...1

Support Software

Single-Ended Input (CNA, CNB)

N.C.	68	34	N.C.	N.C.	1	35	Analog Ground (for AI)
N.C.	67	33	N.C.	N.C.	2	36	Analog Ground (for AI)
N.C.	66	32	N.C.	Analog Ground (for AI)	3	37	Analog Ground (for AI)
N.C.	65	31	N.C.	Analog Input 00	4	38	Analog Input 16
N.C.	64	30	N.C.	Analog Input 01	5	39	Analog Input 17
N.C.	63	29	N.C.	Analog Input 02	6	40	Analog Input 18
N.C.	62	28	N.C.	Analog Input 03	7	41	Analog Input 19
Digital Ground	61	27	N.C.	Analog Ground (for AI)	8	42	Analog Ground (for AI)
N.C.	60	26	N.C.	Analog Input 04	9	43	Analog Input 20
N.C.	59	25	N.C.	Analog Input 05	10	44	Analog Input 21
Digital Ground	58	24	N.C.	Analog Input 06	11	45	Analog Input 22
N.C.	57	23	N.C.	Analog Input 07	12	46	Analog Input 23
Analog Input 63	56	22	Analog Input 47	Analog Ground (for AI)	13	47	Analog Ground (for AI)
Analog Input 62	55	21	Analog Input 46	Analog Input 08	14	48	Analog Input 24
Analog Input 61	54	20	Analog Input 45	Analog Input 09	15	49	Analog Input 25
Analog Input 60	53	19	Analog Input 44	Analog Input 10	16	50	Analog Input 26
Analog Ground (for AI)	52	18	Analog Ground (for AI)	Analog Input 11	17	51	Analog Input 27
Analog Input 59	51	17	Analog Input 43	Analog Ground (for AI)	18	52	Analog Ground (for AI)
Analog Input 58	50	16	Analog Input 42	Analog Input 12	19	53	Analog Input 28
Analog Input 57	49	15	Analog Input 41	Analog Input 13	20	54	Analog Input 29
Analog Input 56	48	14	Analog Input 40	Analog Input 14	21	55	Analog Input 30
Analog Ground (for AI)	47	13	Analog Ground (for AI)	Analog Input 15	22	56	Analog Input 31
Analog Input 55	46	12	Analog Input 39	Input Control External Sampling Start Trigger Input	23	57	Input Control External Sampling Stop Trigger Input
Analog Input 54	45	11	Analog Input 38	Input Control External Sampling Clock Input	24	58	Digital Ground
Analog Input 53	44	10	Analog Input 37	N.C.	25	59	N.C.
Analog Input 52	43	9	Analog Input 36	N.C.	26	60	N.C.
Analog Ground (for AI)	42	8	Analog Ground (for AI)	N.C.	27	61	Digital Ground
Analog Input 51	41	7	Analog Input 35	N.C.	28	62	N.C.
Analog Input 50	40	6	Analog Input 34	Digital Input 00	29	63	Digital Input 01
Analog Input 49	39	5	Analog Input 33	Digital Input 02	30	64	Digital Input 03
Analog Input 48	38	4	Analog Input 32	Digital Output 00	31	65	Digital Output 01
Analog Ground (for AI)	37	3	Analog Ground (for AI)	Digital Output 02	32	66	Digital Output 03
Analog Ground (for AI)	36	2	N.C.	Counter Gate Control Input	33	67	Counter Count-up Pulse Output
Analog Ground (for AI)	35	1	N.C.	Counter Clock Input	34	68	Reserved (Counter Input)

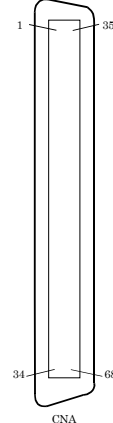
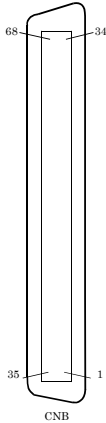

Pin Assignment of interface connector (Single-Ended Input)

Analog Input00 - Analog Input63	Analog input signal. The numbers correspond to channel numbers.
Analog Ground	Common analog ground for analog input signals.
AI External Start Trigger Input	External trigger input for starting analog input sampling.
AI External Stop Trigger Input	External trigger input for stopping analog input sampling.
AI External Sampling Clock Input	External sampling clock input for analog input.
Digital Input00 - Digital Input03	Digital input signal.
Digital Output00 - Digital Output03	Digital output signal.
Counter Gate Control Input	Gate control input signal for counter.
Counter Up Clock Input	Count-up clock input signal for counter.
Counter Output	Count output signal.
Digital Ground	Common digital ground for digital I/O signals, external trigger inputs, external sampling clock inputs, and counter I/O signals.
Reserved	Reserved pin
N.C.	No connection to this pin.

⚠ CAUTION

- Do not connect any of the outputs and power outputs to the analog or digital ground. Neither connect outputs to each other. Doing either can result in a fault.
- If analog and digital ground are shorted together, noise on the digital signals may affect the analog signals. Accordingly, analog and digital ground should be separated.
- Leave "Reserved" pins unconnected. Connecting these pins may cause a fault in the board.

Differential Input (CNA, CNB)

N.C.	68	34	N.C.	1	35	Analog Ground (for AI)
N.C.	67	33	N.C.	2	36	Analog Ground (for AI)
N.C.	66	32	N.C.	Analog Ground (for AI)	37	Analog Ground (for AI)
N.C.	65	31	N.C.	Analog Input 00[+]	38	Analog Input 00[-]
N.C.	64	30	N.C.	Analog Input 01[+]	39	Analog Input 01[-]
N.C.	63	29	N.C.	Analog Input 02[+]	40	Analog Input 02[-]
N.C.	62	28	N.C.	Analog Input 03[+]	41	Analog Input 03[-]
Digital Ground	61	27	N.C.	Analog Ground (for AI)	42	Analog Ground (for AI)
N.C.	60	26	N.C.	Analog Input 04[+]	43	Analog Input 04[-]
N.C.	59	25	N.C.	Analog Input 05[+]	44	Analog Input 05[-]
Digital Ground	58	24	N.C.	Analog Input 06[+]	45	Analog Input 06[-]
N.C.	57	23	N.C.	Analog Input 07[+]	46	Analog Input 07[-]
Analog Input 31[-]	56	22	Analog Input 31[+]	Analog Ground (for AI)	47	Analog Ground (for AI)
Analog Input 30[-]	55	21	Analog Input 30[+]	Analog Input 08[+]	48	Analog Input 08[-]
Analog Input 29[-]	54	20	Analog Input 29[+]	Analog Input 09[+]	49	Analog Input 09[-]
Analog Input 28[-]	53	19	Analog Input 28[+]	Analog Input 10[+]	50	Analog Input 10[-]
Analog Ground (for AI)	52	18	Analog Ground (for AI)	Analog Input 11[+]	51	Analog Input 11[-]
Analog Input 27[-]	51	17	Analog Input 27[+]	Analog Ground (for AI)	52	Analog Ground (for AI)
Analog Input 26[-]	50	16	Analog Input 26[+]	Analog Input 12[+]	53	Analog Input 12[-]
Analog Input 25[-]	49	15	Analog Input 25[+]	Analog Input 13[+]	54	Analog Input 13[-]
Analog Input 24[-]	48	14	Analog Input 24[+]	Analog Input 14[+]	55	Analog Input 14[-]
Analog Ground (for AI)	47	13	Analog Ground (for AI)	Analog Input 15[+]	56	Analog Input 15[-]
Analog Input 23[-]	46	12	Analog Input 23[+]	Input Control External Sampling Start Trigger Input	57	Input Control External Sampling Stop Trigger Input
Analog Input 22[-]	45	11	Analog Input 22[+]	Input Control External Sampling Clock Input	58	Digital Ground
Analog Input 21[-]	44	10	Analog Input 21[+]	N.C.	59	N.C.
Analog Input 20[-]	43	9	Analog Input 20[+]	N.C.	60	N.C.
Analog Ground (for AI)	42	8	Analog Ground (for AI)	N.C.	61	Digital Ground
Analog Input 19[-]	41	7	Analog Input 19[+]	N.C.	62	N.C.
Analog Input 18[-]	40	6	Analog Input 18[+]	Digital Input 00	63	Digital Input 01
Analog Input 17[-]	39	5	Analog Input 17[+]	Digital Input 02	64	Digital Input 03
Analog Input 16[-]	38	4	Analog Input 16[+]	Digital Output 00	65	Digital Output 01
Analog Ground (for AI)	37	3	Analog Ground (for AI)	Digital Output 02	66	Digital Output 03
Analog Ground (for AI)	36	2	N.C.	Counter Gate Control Input	67	Counter Count-up Pulse Output
Analog Ground (for AI)	35	1	N.C.	Counter Clock Input	68	Reserved (Counter Input)

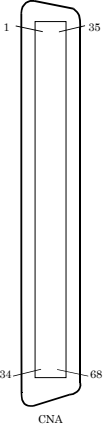
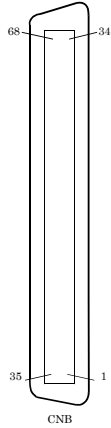

Pin Assignment of interface connector (Differential Input)

Analog Input00 - Analog Input31	Analog input signal. The numbers correspond to channel numbers.
Analog Ground	Common analog ground for analog input signals.
AI External Start Trigger Input	External trigger input for starting analog input sampling.
AI External Stop Trigger Input	External trigger input for stopping analog input sampling.
AI External Sampling Clock Input	External sampling clock input for analog input.
Digital Input00 - Digital Input03	Digital input signal.
Digital Output00 - Digital Output03	Digital output signal.
Counter Gate Control Input	Gate control input signal for counter.
Counter Up Clock Input	Count-up clock input signal for counter.
Counter Output	Count output signal.
Digital Ground	Common digital ground for digital I/O signals, external trigger inputs, external sampling clock inputs, and counter I/O signals.
Reserved	Reserved pin
N.C.	No connection to this pin.

⚠ CAUTION

- Do not connect any of the outputs and power outputs to the analog or digital ground. Neither connect outputs to each other. Doing either can result in a fault.
- If analog and digital ground are shorted together, noise on the digital signals may affect the analog signals. Accordingly, analog and digital ground should be separated.
- Leave "Reserved" pins unconnected. Connecting these pins may cause a fault in the board.