

Contact Details

Before using the product, please check the guide pages at the front of this catalog.

Internet

<https://www.daikinpmc.com/en/>

For latest information, PDF catalogs and operation manuals

Flow Control Valves and Flow Control Valves with Check Valve (with Pressure/Temperature Compensation Control)

PDF Compressor Free Version



JIS graphic symbols for hydraulic system

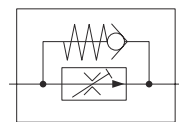
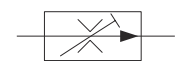

Features

- The valves with pressure/temperature compensation control can maintain the set flow rate regardless of changes in the load pressure and fluid temperature.
- Capable of flow control over a wide range from minimal flow rate to high quantity flow rate.
- The four full turns of the flow rate adjusting handle make fine adjustment and resetting easy.
- Options such as a flow rate adjusting handle locking key and jumping prevention structure are available.

Nomenclature

※ - **JF** ※ - **G** ※ ※ - ※ ※ ※ - ※ ※ - ※ ※
1 2 3 4 5 6 7 8 9

1 Applicable fluid code

No designation: Petroleum-based hydraulic fluid, water-glycol hydraulic fluid
 F: Phosphate ester hydraulic fluid

2 Model No.

JF: J series flow control valve

3 Check valve code

No designation: Without check valve
 C: With check valve

4 Connections

G: Gasket mount type

5 Nominal diameter

02: ¼
 03: ⅜

6 Maximum control flow rate

30: 30 L/min <Only applicable with the nominal diameter of "02">
 105: 105 L/min <Only applicable with the nominal diameter of "03">

7 Design No.

(The design No. is subject to change)

15: Basic model JF -G02, JFC-G02
 16: Basic model JF -G03
 17: Basic model JFC-G03

8 Option code I

No designation: Without flow rate adjusting handle locking key
 L: With flow rate adjusting handle locking key

9 Option code II

No designation: Without jumping prevention structure
 N: With jumping prevention structure

Specifications

Model code	Nominal diameter	Maximum operating pressure MPa {kgf/cm ² }	Flow rate adjustment range*1 L/min	Free flow L/min	Check valve Cracking pressure MPa {kgf/cm ² }	Mass kg
JF -G02- 30-15	¼	21 {210}	Up to 30	30	0.035 {0.35}	3.9
JFC-G02- 30-15						
JF -G03-105-16	⅜	21 {210}	Up to 105	105	0.035 {0.35}	8.3
JFC-G03-105-17						

Note: *1 The minimum control flow rate varies depending on the pressure difference between the inlet and outlet ports. See the valve differential pressure - minimum control flow rate characteristics for details.

Sub-plate model code

- The sub-plate is not provided with the valve. Order it separately if required by specifying the model code given in the table below.

Model code	Nominal diameter	Connection port diameter	Mass kg
JF-02M03	¼	Rc⅜	2.3
JF-02M04		Rc½	
JF-03M	⅜	Rc⅜	3.2
JF-03M06		Rc¾	
JF-03M08		Rc1	

Refer to Page S-8 for the dimensions of the sub-plate.

Accessories

Model No.	Hexagon socket head cap bolt	Quantity	Tightening torque N·m {kgf·cm}
JF (C) -G02	M 8 × 55	4	25 to 30 {250 to 300}
JF (C) -G03	M10 × 80	4	48 to 63 {480 to 630}

Handling

- When controlling a flow rate of 0.2 L/min or less with JF(C)-G02 or 0.5 L/min or less with JF(C)-G03, use the valve in combination with a line filter with a filtration accuracy of 10 μm or better.
- To ensure good pressure compensation performance, maintain a pressure difference of 1 MPa {10 kgf/cm²} minimum between the inlet and outlet ports.
- Seal the O-ring (Part No. 25 in the sectional structural diagram) at the rear of the flow rate adjusting handle with the gasket face.

Performance curves (viscosity: 32 mm²/s {cSt})

PDF Compressor Free Version

● JF(C)-G02

Scale - Flow rate characteristics

Pressure difference between inlet and outlet ports:
21 MPa {210 kgf/cm²}

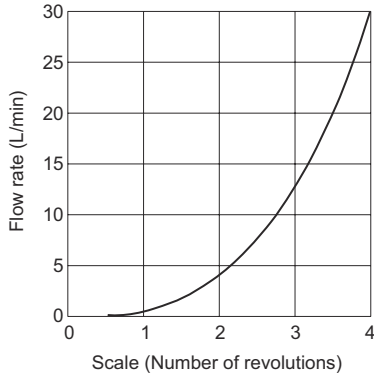

Valve differential pressure -
Flow rate characteristics

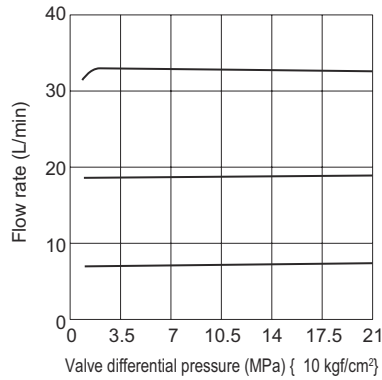

Fluid temperature - Flow rate characteristics

Pressure difference between inlet and outlet ports: 21 MPa {210 kgf/cm²}

Fluid used: equivalent to ISO VG32

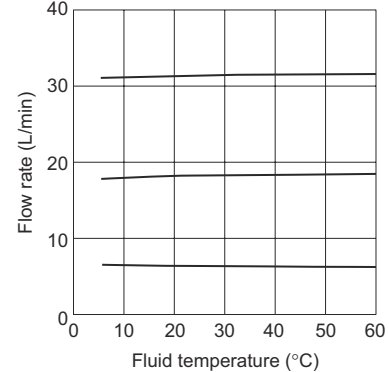

Valve differential pressure -

Minimum control flow rate characteristics

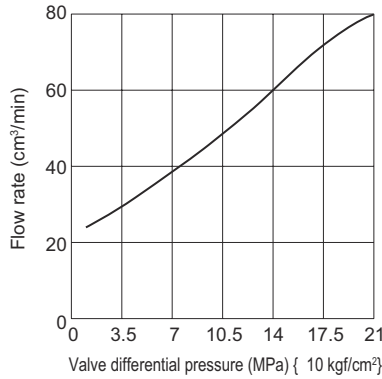

Free Flow pressure drop characteristics

(with the flow rate adjusting section fully closed)

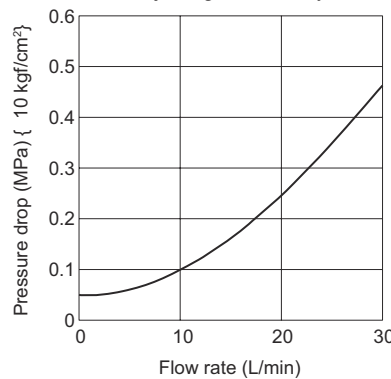

● JF(C)-G03

Scale - Flow rate characteristics

Pressure difference between inlet and outlet ports:
21 MPa {210 kgf/cm²}

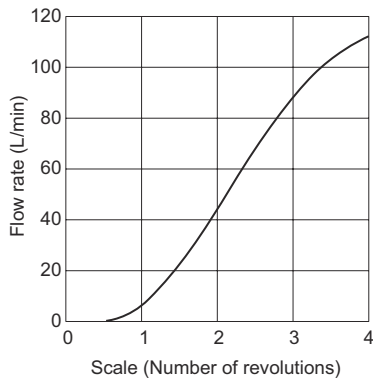

Valve differential pressure -
Flow rate characteristics

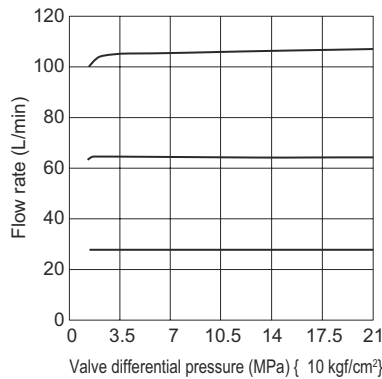

Fluid temperature - Flow rate characteristics

Pressure difference between inlet and outlet ports: 21 MPa {210 kgf/cm²}

Fluid used: equivalent to ISO VG32

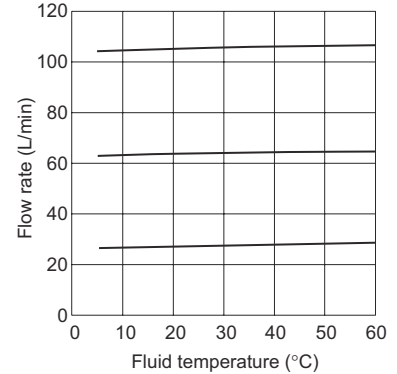

Valve differential pressure -

Minimum control flow rate characteristics

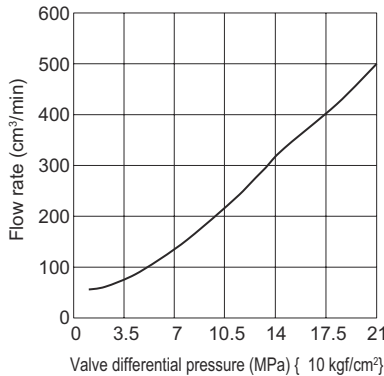

Free flow pressure drop characteristics

(with the flow rate adjusting section fully closed)

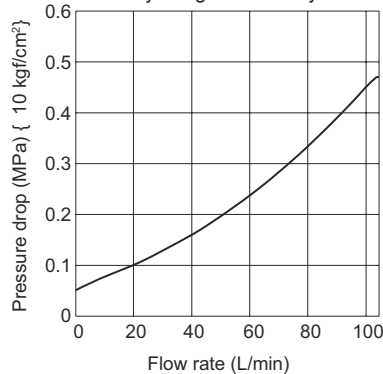

Contact Details

Before using the product, please check the guide pages at the front of this catalog.

Internet

<https://www.daikinpmc.com/en/>

For latest information, PDF catalogs and operation manuals

External dimension diagram

PDF Compressor Free Version

JF(C)-G**

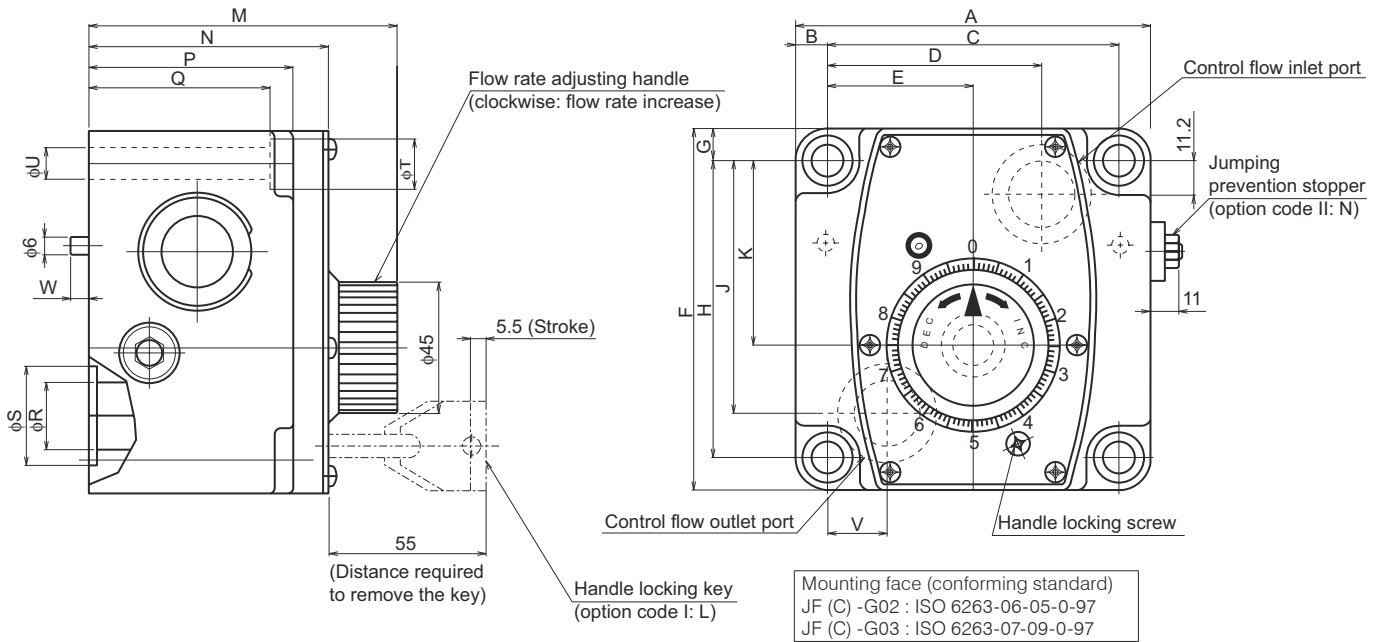

Model No.	Dimensions																			
	A	B	C	D	E	F	G	H	J	K	M	N	P	Q	R	S	T	U	V	W
JF (C) -G02	95.3	9.5	76.2	53.8	38.1	101.6	9.5	82.6	52.4	47.1	86	62	50	42	14	22	14	9	9.5	6.5
JF (C) -G03	124	11.2	101.6	74.9	50.8	124	11.2	101.6	86.6	62.8	108	84	71.5	63.5	23	34	17.5	11	20.6	6

Sectional structural diagram

JF(C)-G**

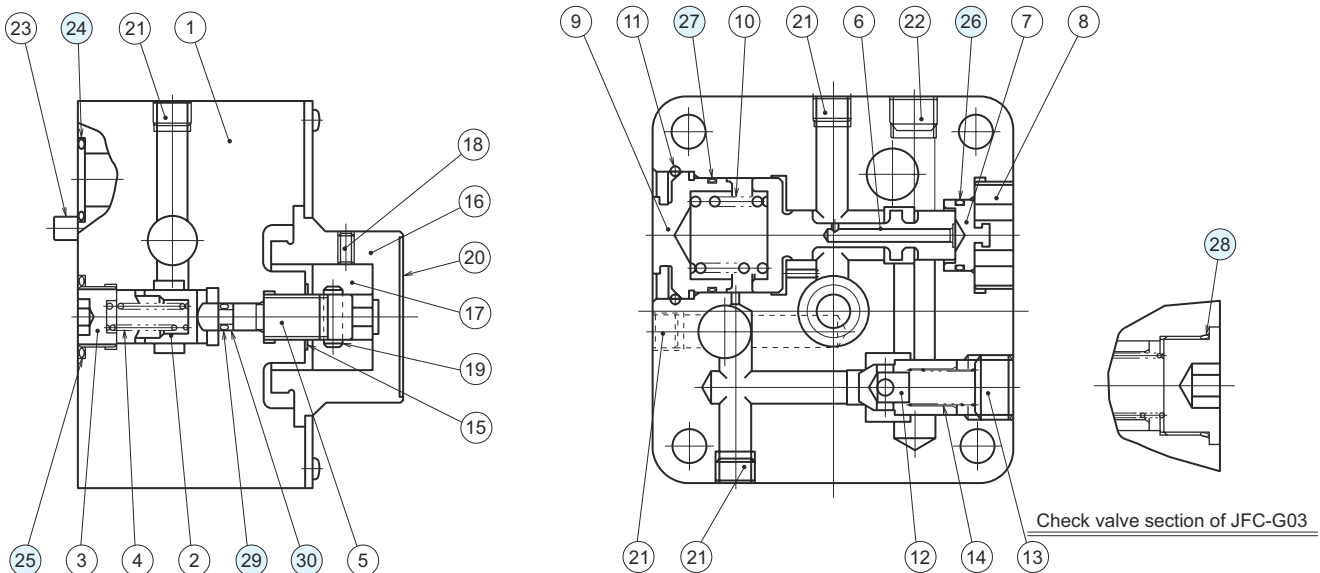

Sealing part table

Part No.	Name	Quantity	Part specifications		
			JF (C)-G02	JF-G03	JFC-G03
24	O-ring	2	JIS B 2401 1B P18	JIS B 2401 1B P28	JIS B 2401 1B P28
25	O-ring	1	JIS B 2401 1B P18	JIS B 2401 1B G25	JIS B 2401 1B G25
26	O-ring	1	AS568-016 (NBR,Hs90)	JIS B 2401 1B P15	JIS B 2401 1B P15
27	O-ring	1	AS568-023 (NBR,Hs90)	AS568-028 (NBR,Hs90)	AS568-028 (NBR,Hs90)
28	O-ring	1	-	-	AS568-021 (NBR,Hs90)
29	O-ring	1	JIS B 2401 1A P4	JIS B 2401 1A P4	JIS B 2401 1A P4
30	Backup ring	1	JIS B 2407 for P4 (bias cut)	JIS B 2407 for P4 (bias cut)	JIS B 2407 for P4 (bias cut)