

SG3-50-275-N

Spark Gap Surge Diverter

Use Spark Gap Surge Diverters for point of entry protection at main switchboards where direct strike protection is required.



Wiring

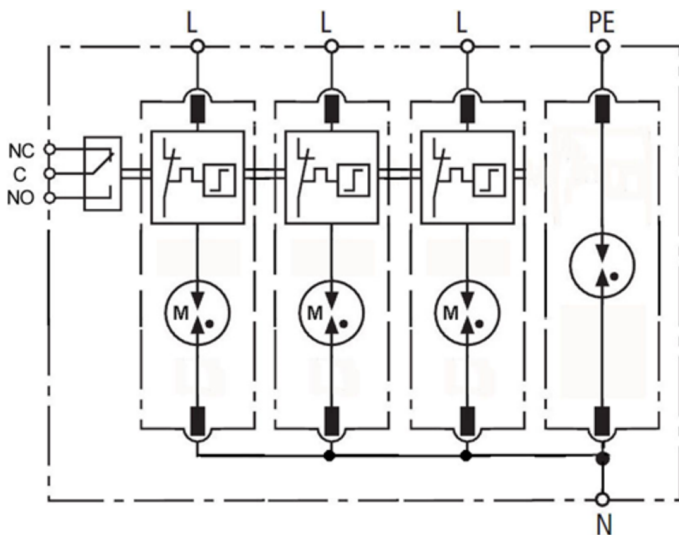

Dimensions

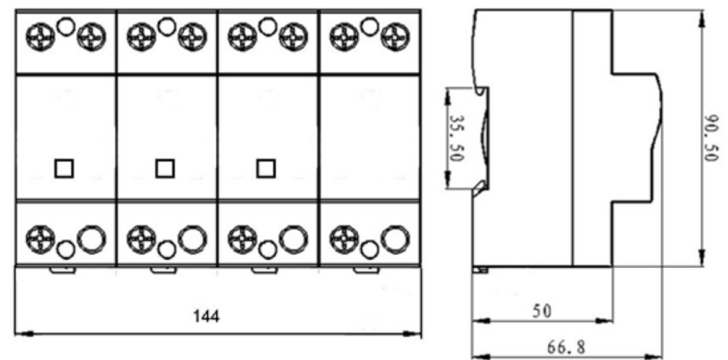





Standards

- IEC 61643-11:2011 SPD connected to low-voltage power systems - Type 1
- AS/NZS 1768:2007 A.C. power system SPD - Cat C
- UL 1449 3rd edition Low voltage SPD - Type 2 (distribution)
- IEEE 62.41.2:2002 Low voltage SPD - Cat B (indoor)

Specifications

Electrical Specifications

Connection type		Series
Modes of protection		L-N, N-PE
Number of ports		2
Number of phases		3
Location		Indoor
Nominal voltage	U_0	230VAC
Short circuit withstand level	I_{SSCR}	50kA
Maximum backup fuse		500A



Electrical (L-N) Specifications

Maximum continuous voltage AC	U_c	275VAC
Maximum discharge current (8/20 μ s)	I_{max}	150kA
Nominal discharge current (8/20 μ s)	I_n	50kA
Lightning impulse current (10/350 μ s)	I_{imp}	50kA
Voltage protection level (6kV 1.2/50 μ s)	U_p	<1300V
Response time	t_A	<100ns







Electrical (N-PE) Specifications

Maximum continuous voltage	U_c	255VAC
Maximum discharge current (8/20 μ s)	I_{max}	150kA
Lightning impulse current (10/350 μ s)	I_{imp}	120kA
Nominal discharge current (8/20 μ s)	I_n	120kA
Voltage protection level (6kV 1.2/50 μ s)	U_p	<1500V
Response time	t_A	<100ns

Indication Specifications

Display		Mechanical flag
Alarm		Thermal failure
Alarm isolation		4kV

Mechanical Specifications

Minimum operating temperature		-40°C
Maximum operating temperature		80°C
Minimum operating humidity		5%
Maximum operating humidity		95%
Mounting method		TS35 DIN Rail
Environmental rating		IP20
Enclosure material		Polycarbonate
Enclosure finish		Textured Black
Terminal capacity - power		35mm ²
Terminal screw torque - power		2Nm
Terminal capacity - alarms		1.5mm ²
Terminal screw torque - alarms		0.5Nm
Length		91mm
Width		144mm
Height		67mm

Other Specifications

Product Code  SG3-50-275-N

Shipping Specifications

Weight		500g
Customs tariff		85354010